



Burlington[®]

Burlington enables homeowners to create bathrooms with the authentic forms and finishes from pivotal periods of design but made to modern quality and performance standards.

Burlington brings the finest quality complete traditional bathroom ranges with genuine and inspired designs from the late 19th Century through to the 1930s. In an age of minimalism and stark, functional spaces, Burlington offers a sanctuary for those who seek the comfort, familiarity and reassurance of more traditional styling. Burlington's collections include everything you need; brassware, ceramics, furniture, baths, shower enclosures, towel radiators and accessories.



Edwardian 515mm cloakroom basin | 3" pillar taps with Claremont handles | Soap dish | Towel ring | WC roll holder | WC brush holder | Rectangular mirror | Edwardian single round LED light | Guild Back to wall WC with concealed cistern and flushplate | Guild soft close seat, Green | All fittings, brassware and accessories are in Chrome

INSPIRATION

02 FREESTANDING CLASSICS

12 ELEGANT EDWARDIAN

24 OPULENT VICTORIAN

30 A MODERN TWIST

40 CHALFONT CHIC

48 ICONIC RIVIERA

56 CLOAKROOMS

TECHNICAL DIRECTORY

66 WCs

86 BASINS

100 FURNITURE

114 BATHS

124 BRASSWARE

132 SHOWERING

154 ACCESSORIES



650mm freestanding vanity unit with doors, Grey with Classic 650 basin | 5" pillar tap with Claremont handles | Basin plug & chain | 600 framed mirror, White

FREESTANDING CLASSICS

Functional. Time-honoured. Traditional.

Captivating and timeless designs are captured by our Freestanding furniture units, combining classic styling with the practicality of ample storage. Perfect for incorporating in modern or traditional bathroom designs alike, to maximise storage with a timeless look. Sophisticated storage with modern-day performance, from smaller basin units to impressive vanity units, square edges or softer curves, in a selection of tasteful hues our Freestanding furniture will enhance your bathroom design.





980mm freestanding vanity unit with doors, Black with Minerva White worktop | Mono swan neck basin mixer | Tumbler holder | WC roll holder | WC brush holder | Arch mirror | Mirror fixings 1909 | Ornate light with tube frosted glass shade | Standard low level dual flush WC with flush pipe | Soft close seat, White | Sliding door enclosure 800x1200 | 1909 handle and finials | Bowood shower tray | Trent shower with 9" head | Bloomsbury radiator | All fittings, brassware and accessories are in Brushed Nickel



Regal high level WC with flush pipe, dual flush ceramic cistern and cover caps | Soft close seat, Green | WC roll holder | WC brush holder | Towel ring | Regent 3 tap hole mixer with Claremont handles | 750mm freestanding vanity unit with doors, Green with Minerva White worktop | Rectangular swivel mirror with curved corners | Walk in, corner with T brace | Avon thermostatic shower with wall bracket, handset and 9" head | Bloomsbury radiator | All fittings and accessories are in Brushed Nickel







Standard low level WC with flush pipe, lever and cover caps | Soft close seat, White | WC roll holder | Towel ring | Three tap hole with Claremont handles | Curved 1340mm freestanding vanity unit with drawers, White with Minerva Carrara marble worktop | Framed 1200mm mirror with LED illuminations, White | Hampton 1700mm bath | Wall mounted bath shower mixer with Claremont handles | Walk in, corner with T brace | Trent shower with 9" head | All fittings and accessories are in Brushed Nickel



Standard low level WC with flush pipe, lever and cover caps | Soft close seat, Blue | WC roll holder | Towel ring | Regent three tap hole with Claremont handles | Curved 1340mm freestanding vanity unit with doors, Blue with Minerva Carrara marble worktop | Framed 1200mm mirror with LED illuminations, Blue / Admiral 1650mm bath | Deck mounted bath shower mixer with Claremont handles | Stand pipes | All fittings and accessories are in Gold





Edwardian 1200mm double basin with washstand | Three tap hole mixers with Claremont handles | Towel rings | All fittings and accessories are in Gold

ELEGANT EDWARDIAN

Classic. Soothing. Refreshing.

Famed for their restorative properties, Edwardian design took inspiration from the styles of the previous centuries whilst focusing on making comfort a high priority. Warming neutrals lay the perfect foundation with their soft, balanced hues helping to create a lighter cosy homeliness. A perfect pairing with expressive coloured tiles or patterned wallpaper, Edwardian style provides complete contentment without having to compromise on a look that dates.



Right: Edwardian 560mm basin with full pedestal | 5" pillar tap with Claremont handles | Standard close coupled WC with lever | Soft close seat, White
Above: London round bath | Deck mounted bath shower mixer with White Kensington handles | Stand pipes | Brass extendible bath rack |
All fittings, brassware and accessories are in Chrome





Hampton 1500mm bath with traditional feet | Classique bathscreen | Tay exposed shower with 9" shower head | Edwardian 560mm basin with full pedestal | Three tap hole mixer with Kensington handles | Towel ring | Soap dish | Double robe hook | WC roll holder | Oval mirror | Mirror fixings 1850 | Round lights with cup frosted glass shades | Regal back to wall WC with lever | Soft close seat, Oak | All fittings, brassware and accessories are in Chrome





THE
Burlington
Patent System



Edwardian 1200mm basin with washstand | Three tap hole mixer with Claremont handles | Standard 440 medium level WC with Chrome cistern with flush pipe and lever | Soft close seat, White | Seat handles | All fittings, brassware and accessories are in Chrome





Left: Three tap hole mixer with Birkenhead handles / Soap dish / Standard 520 low level WC with flush pipe and lever | Soft close seat, White | WC roll holder
Above: Edwardian 800mm basin with washstand | All fittings, brassware and accessories are in Chrome





Above Clockwise: Edwardian 515mm cloakroom basin | Towel rail | 3" pillar taps with Claremont handles / Claremont Bath Shower Mixer Deck Mounted / Standard 520 medium level WC with flush pipe and lever | Soft close seat, Oak / Glass shelf with railing / All fittings, brassware and accessories are in Chrome
 Left: Edwardian 560mm round basin with washstand | 3" pillar taps with White Kensington handles | Tumbler holder and spare WC roll holder | Back to wall WC with concealed cistern and lever | Soft close seat, White | All fittings, brassware and accessories are in Chrome



Victorian 610mm basin with full pedestal | 5" pillar taps with Claremont handles | Rectangular mirror with rounded corners | Soap dispenser | Glass shelf | WC roll holder
| WC brush holder | Standard 520 close coupled WC with lever and cover caps | Soft close seat, Green | All fittings, brassware and accessories are in Gold

OPULENT VICTORIAN

Decorative. Characterful. Ornate.

Discover the delightful details of Victorian design, whether you are looking to restore your home to full Victorian splendour or you want to add some character to your modern home. The Victorian era was all about mixing and matching styles to create an impactful interior, be inspired by the distinct style of this era and make your own modern day statement. Our Victorian products are the perfect partner for patterned wallpapers with rich colours or light and airy interiors alike.





Victorian 610mm basin with full pedestal | 5" pillar taps with Claremont handles | Rectangular mirror with rounded corners | Soap dispenser | Glass shelf | WC roll holder | WC brush holder | Arundel Double Ended 1700x700 with side panels, Green | Bath shower mixer wall mounted with Claremont handles | All fittings, brassware and accessories are in Gold



Victorian 560mm basin with regal stand and towel rack | 3" pillar taps with Claremont handles | Tumbler | Towel ring | WC roll holder | Standard 520 low level WC with flush pipe, lever and cover caps | Soft close seat, White | Arundel 1700mm x 700mm bath with panels, White | Deck mounted bath shower mixer | All fittings, brassware and accessories are in Gold





1300mm freestanding vanity unit with doors, Black with Minerva Carrara marble worktop | Regent three tap hole mixers with Claremont handles | Rectangular mirror | Mirror fixings 1850 | Ornate lights with vase clear glass shades | All fittings, brassware and accessories are in Chrome

A MODERN TWIST

Contemporary. Time-honoured. Everlasting.

Known as the principles of art; balance, harmony and proportion are often cited within classic bathrooms inspired by eminent eras such as Victorian, Edwardian and Art Deco. Defined by symmetry, soft corners and structure, classic bathrooms maximise comfort by combining traditional design with modern-day elements. Whether you love the look of traditional or prefer the modern feel, our contemporary collections unite form and function for elegantly refined designs.



1300mm freestanding vanity unit with doors, Black with Minerva Carrara marble worktop | Regent three tap hole mixers with Claremont handles | Rectangular mirror | Mirror fixings 1850 | Ornate lights with vase clear glass shades | Hinged door recess enclosure 900x1000 | 1850 handle and finials | Calton shower tray | Avon shower with 9" head | Chaplin radiator | Standard medium level WC with flush pipe, dual flush ceramic cistern and cover caps | Soft close seat, Black | WC roll holder | WC brush holder | All fittings, brassware and accessories are in Chrome

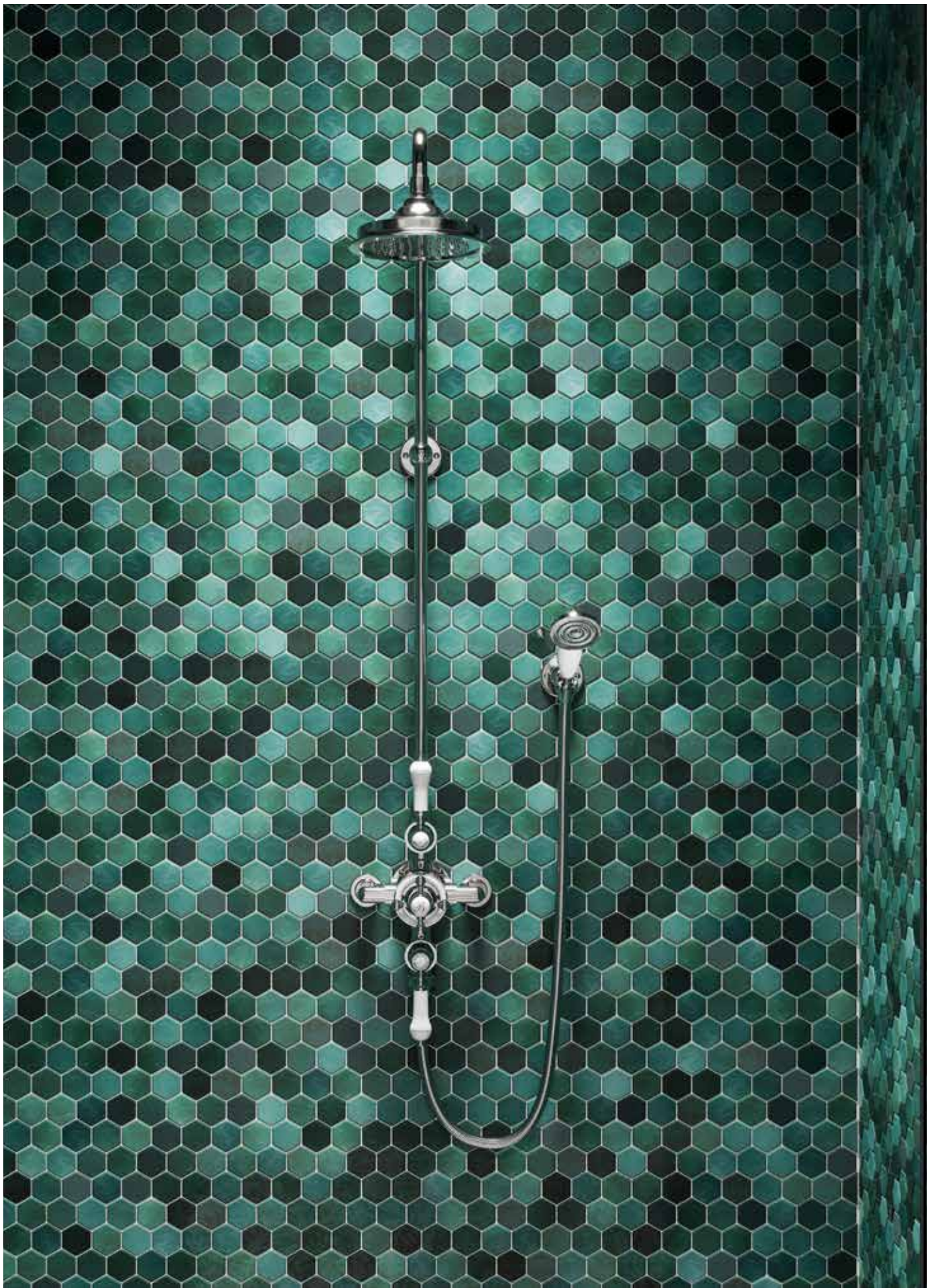

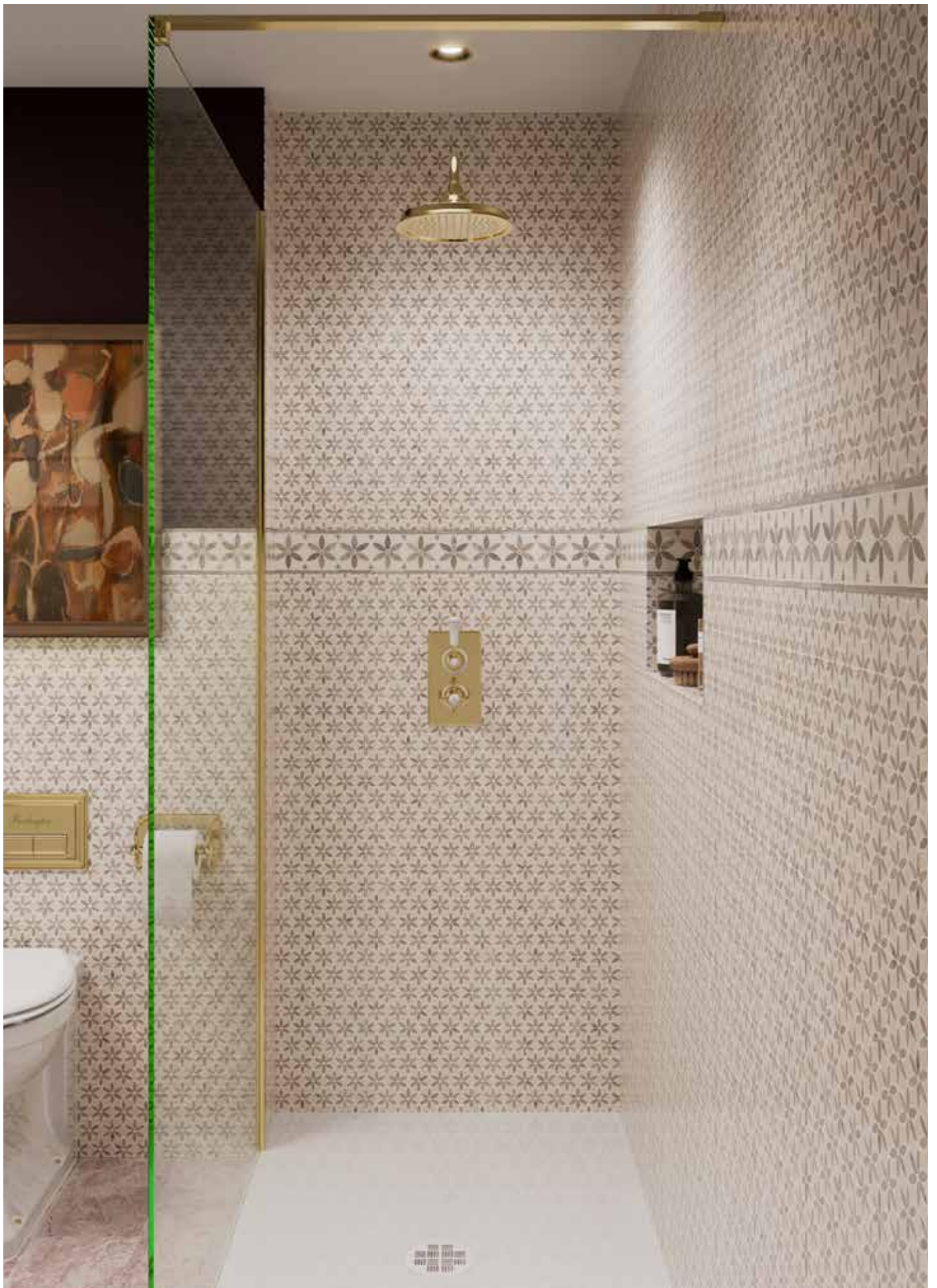



Chalfont 650mm vanity unit in Grey with matching Chalfont basin and Gold handle | Three tap hole mixer with Claremont handles | Soap dish | Towel ring | Tumbler holder | Rectangular mirror | Mirror fixings 1850 | WC roll holder | WC brush holder | Standard back to wall WC | Concealed cistern with Flushplate | Soft close seat, White | Trent shower with 9" head | Burlington walk in shower enclosure | Bowood 25mm Shower tray | All fittings, brassware and accessories are in Gold





Contemporary Upstand 560mm basin with stand and towel rack | Mono basin mixer with Claremont handles | Soap dish | Towel ring | Standard 520 close coupled WC with lever and cover caps | Soft close seat, White | Walk in, recess with hinged deflector | Avon thermostatic shower with wall bracket, handset and 9" head | Trafalgar radiator | All fittings, brassware and accessories are in Brushed Nickel



Classic 650mm rectangular basin with invisible overflow with pedestal | 5" pillar taps with Claremont handles | Tumbler holder | Towel ring | All fittings, brassware and accessories are in Chrome





Chalfont 550mm vanity unit in Grey with matching Chalfont basin and Gold handle | Regent three tap hole mixer with Claremont handles | Soap dispenser | Towel ring | WC roll holder | WC brush holder | Mirrored cabinet, Grey | Standard low level dual flush WC with flush pipe and Gold cistern | Soft close seat, grey | All fittings, brassware and accessories are in Gold

CHALFONT CHIC

Original. Timeless. Iconic.

A seamless blend of classic and contemporary, modern traditional bathrooms unite extraordinary eras of design to instil newfound comfort. Revolving around an assortment of textures, colours and styles, modern traditional bathrooms can be as classic or contemporary as desired to match individual preference. Beautifully paired with Chrome, Gold or Brushed Nickel, modern traditional bathrooms create design freedom with a look that lasts.

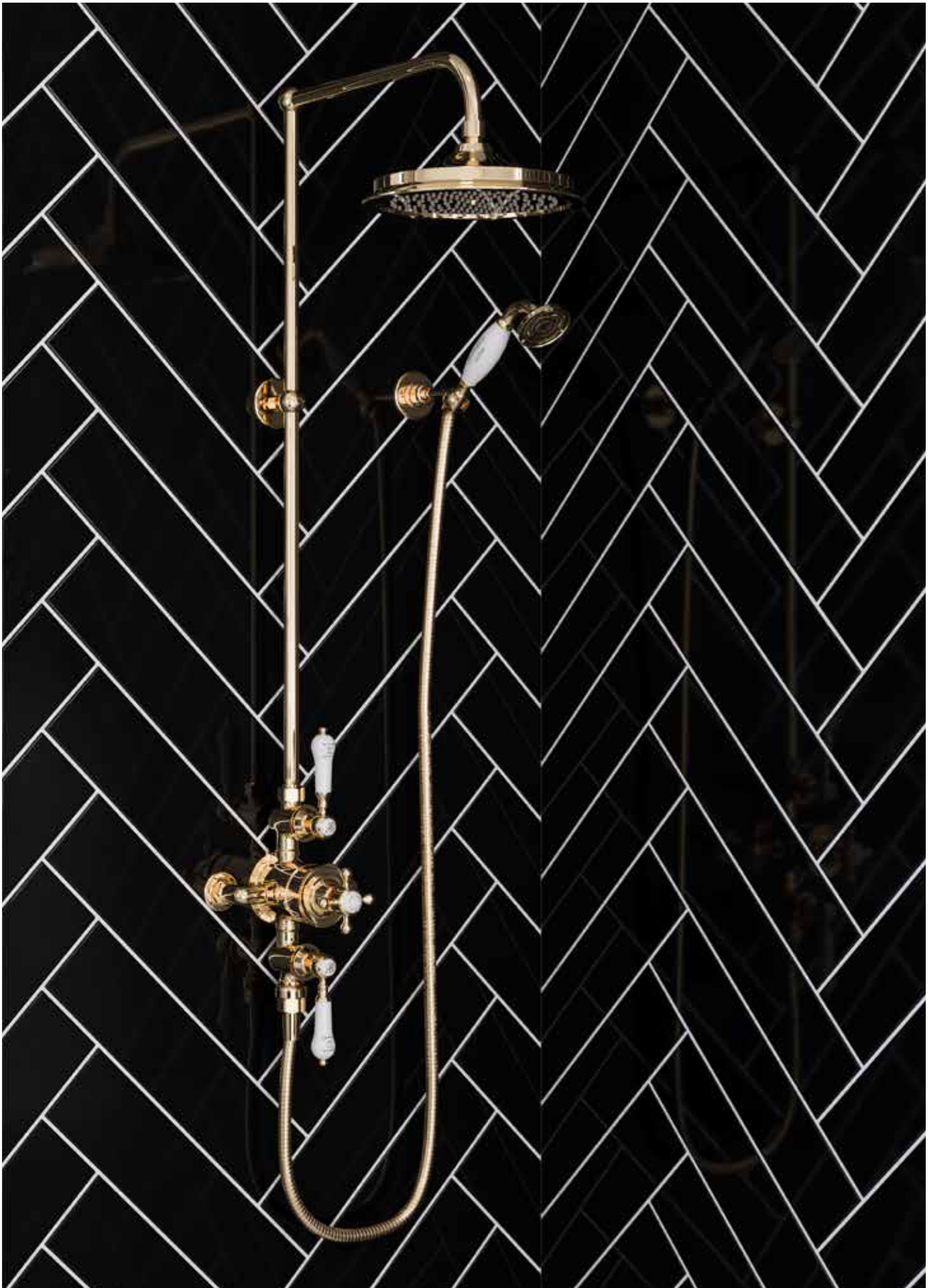

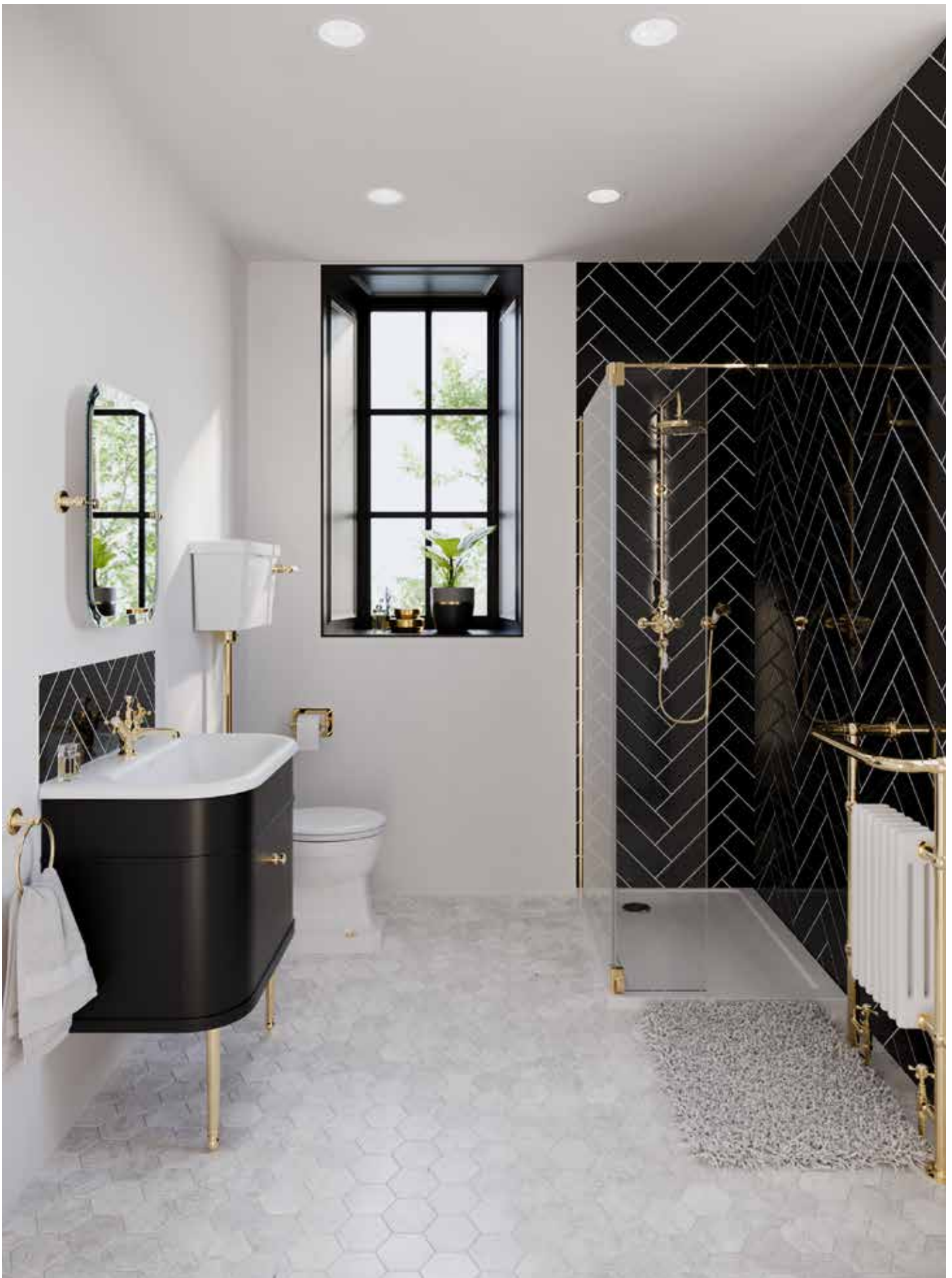

Chalfont 750mm vanity unit Black with large roll top basin, Gold legs and handle | Mono basin mixer with Claremont handles | Towel ring | Rectangular mirror with curved corners | Standard 520 low level WC with flush pipe, lever and cover caps | Soft close seat, White | Avon exposed shower with 9" shower head | Burlington walk in shower enclosure | 35mm Shower tray with Gold waste cover | Trafalgar radiator | All fittings, brassware and accessories are in Gold



Chalfont 650mm vanity unit in Blue with medium roll top basin, Blue legs and Brushed Nickel handle | Arcade three tap hole mixer with crosshead lever | Tumbler holder | Towel ring | WC roll holder | Rectangular swivel mirror | Oval lights with White fine pleated shade | Standard high level dual flush WC with flush pipe | Soft close seat, Blue | Bateau bath | All fittings, brassware and accessories are in Brushed Nickel







Chalfont 550mm vanity unit in Grey with matching Chalfont basin and Gold handle | Regent three tap hole mixer with Claremont handles | Soap dispenser | Towel ring | WC roll holder | WC brush holder | Mirrored cabinet, Grey | Standard high level dual flush WC with flush pipe | Soft close seat, grey | Windsor bath | Gold bath feet | Deck mounted bath shower mixer with Claremont handles | All fittings, brassware and accessories are in Gold



Riviera 650mm vanity unit Blue with Ribbon handles and Riviera square basin | Riviera two tap hole mixer | Soap dish | Oval mirror | Mirror fixings 1909 | Riviera back to wall WC | Concealed cistern with Flushplate | WC roll holder | Freestanding WC brush holder | All fittings, brassware and accessories are in Chrome

ICONIC RIVIERA

Lavish. Luxurious. Exclusive.

Created in collaboration with Christian Booth Design, the Riviera Collection reignites the spirit of the 1920s with a curated selection of ceramics, vanity units and brassware. Drawing on the extravagance of the Mediterranean coasts, Riviera balances clean lines, geometric shapes and decorative embellishments to bring Art Deco designs into homes of today. Faithful to the original and entirely transitional, the Riviera Collection seeks to unite glamour, style and luxury in one comprehensive collection to inspire an Art Deco bathroom unlike any other.





Riviera 580mm vanity unit in Black with handles and Riviera square basin | Riviera three tap hole basin mixer | Soap dish | Towel ring | Oval mirror | Mirror fixings 1850 | Round lights with white fine pleated shades | Quadrant enclosure 800x800 | 1850 handle and finials | Bowood shower tray | Riviera dual outlet shower with fixed hose and handspray | 9" shower head and arm | Cleaver radiator | Riviera bath/shower mixer with bath legs | Bateau bath | Traditional bath feet | Riviera close coupled full back to wall WC | All fittings, brassware and accessories are in Gold



Riviera 580mm vanity unit White with Tier handles and Riviera square basin | Riviera wall mounted three tap hole mixer | Soap dispenser | Oval mirror | Mirror fixings 1909 | Double robe hook | Trafalgar Radiator | Florenza Bath | Riviera bath shower mixer with handset | Riviera stand pipes | All fittings, brassware and accessories are in Gold





Riviera dual valve, slide rail, handset and hose, and 9" shower head | Riviera 580mm D shaped basin with semi pedestal | Towel ring | Shower basket | WC roll holder | Arched mirror | Round lights with tube frosted glass shades | Riviera wall hung WC with concealed cistern and lever | Riviera soft close seat | All fittings, brassware and accessories are in Chrome





650mm freestanding vanity unit, Green with Minerva White Carrara marble worktop | Mono basin mixer | Framed mirror, Green | Bloomsbury radiator | Standard high level dual flush WC with flush pipe and Brushed Nickel cistern | Soft close seat, Green | WC roll holder | WC brush holder | All fittings and brassware are in Brushed Nickel

CLOAKROOMS

Compact. Sophisticated. Endearing.

Just as exciting as renovating the bathroom, the process of bringing an impressive design statement to a compact cloakroom space can feel particularly rewarding. The task of transforming a cloakroom is not only an exciting one, but an effortless one with an extensive selection of products specially designed to enhance these smaller areas. Whether you're looking for Victorian, Edwardian, Art Deco or freestanding designs, with Burlington you can find the perfect solution for your cloakroom.





Edwardian 515mm cloakroom basin with washstand | 3" pillar taps with Claremont handles | Towel ring | WC roll holder | Wall hung WC with concealed cistern and lever | Soft close seat, White | All fittings, brassware and accessories are in Gold



Edwardian 515mm cloakroom basin with matching Black cloakroom vanity unit | 3" pillar taps with Claremont handles | Soap dispenser | Towel ring | Oval mirror | Mirror fixings 1850 | WC roll holder | Freestanding WC brush holder | Wall Hung WC with concealed cistern and flushplate | Soft close seat, White | All fittings, brassware and accessories are in Brushed Nickel





Riviera 450mm cloakroom basin | Riviera pillar taps | Soap dish | Towel ring | WC roll holder | Riviera back to wall WC with concealed cistern and lever | Riviera soft close seat | All fittings, brassware and accessories are in Gold



TECHNICAL DIRECTORY

You have now been introduced to the wide scope of the Burlington collections, all designed and engineered to provide solutions for your bathroom. The following Technical Directory provides a full listing of the Burlington products including product codes and dimensions. Whatever you choose, we are sure you will be delighted with your traditional bathroom by Burlington.

Visit our website burlingtonbathrooms.com if you need further details.



Regent three tap hole mixer with Claremont handles | Towel ring | 750mm freestanding vanity unit with doors, Green with Minerva White worktop | Rectangular swivel mirror with curved corners | All fittings and accessories are in Brushed Nickel

TECHNICAL DIRECTORY

66

WCs

82

BASINS

98

FURNITURE

112

BATHS

122

BRASSWARE

132

SHOWERING

154

ACCESSORIES

WCs

The widest range of traditional WC options to suit your installation and match the exact look you want. Available in White with finish options of Chrome, Gold and Brushed Nickel flush pipes.

PAN OPTIONS

Choose between Standard or Regal WCs with an option of Rimless pans available across a number of our products.



Regal

At Burlington we've created a range that's taller than average sanitaryware. Regal WC pans are 60mm higher than the standard option.



Standard

Our standard WC offers a pan that is 420mm with a box rim. A popular choice for creating a traditional look in your bathroom.



Rimless

The rimless WC is exceptionally easy to keep clean. Its powerful flush covers the entire bowl, making it the most hygienic option.

STYLE OPTIONS

Burlington has a wide range of WCs options. Select your style below.



Wall-hung



Back-to-wall



Close-coupled



Low level



Medium level

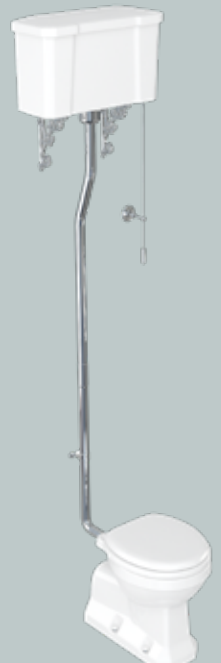

High level

WCs

68

CLOSE COUPLED

70

LOW LEVEL

72

MEDIUM LEVEL

74

HIGH LEVEL

76

OTHERS

77

ARCADE

78

SEATS & ACCESSORIES

80

FLUSH OPTIONS

82

RIVIERA

84

GUILD

QUALITY

For peace of mind our WCs have the following benefits.



All Burlington close-coupled WCs are supplied with dual flush WRAS fittings.



All WCs have a unique stay-clean NANO Glaze coating, creating an ultra-smooth surface, six times smoother than standard ceramic.

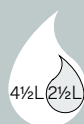

All Burlington WC fittings are factory set at 3L and 6L flush. They can be adjusted on site to flush at 2½L and 4½L.

GUARANTEES

*The lifetime guarantee is subject to online registration and represents the perceived lifetime of the product which is 25 years. For full details on guarantees please visit burlingtonbathrooms.com/guarantee.

WCs

LIFETIME

Guarantee*

CLOSE COUPLED

Standard Close Coupled WC



520 Cistern with Lever

W: 520 D: 730 H: 780

Codes: P5 + C1

440 Cistern with Lever

W: 440 D: 730 H: 780

Codes: P5 + C3

520 Cistern with Button

W: 520 D: 730 H: 780

Codes: P5 + C2

440 Cistern with Button

W: 440 D: 730 H: 780

Codes: P5 + C4

Regal Close Coupled WC



520 Cistern with Lever

W: 520 D: 730 H: 845

Codes: P12 + C1

440 Cistern with Lever

W: 440 D: 730 H: 845

Codes: P12 + C3

520 Cistern with Button

W: 520 D: 730 H: 845

Codes: P12 + C2

440 Cistern with Button

W: 440 D: 730 H: 845

Codes: P12 + C4

Rimless Close Coupled WC



520 Cistern with Lever

W: 520 D: 730 H: 780

Codes: P20 + C1

440 Cistern with Lever

W: 440 D: 730 H: 780

Codes: P20 + C3

520 Cistern with Button

W: 520 D: 730 H: 780

Codes: P20 + C2

440 Cistern with Button

W: 440 D: 730 H: 780

Codes: P20 + C4

Please note: Seats sold separately

For alternative Lever finishes,
See page 80.

S Trap Close Coupled WC

520 Cistern with Lever

W: 520 D: 710 H: 780

Codes: P18 + C1

440 Cistern with Lever

W: 440 D: 710 H: 780

Codes: P18 + C3

520 Cistern with Button

W: 520 D: 710 H: 780

Codes: P18 + C2

440 Cistern with Button

W: 440 D: 710 H: 780

Codes: P18 + C4

Back entry cistern option available, see page 79



For full details on our WC ranges go to burlingtonbathrooms.com/guides/toilets

LOW LEVEL

Standard Low Level WC



520 Cistern with Lever

W: 520 D: 740 H: 1075

Codes: P2 + C1 + T31CHR

440 Cistern with Lever

W: 440 D: 740 H: 1075

Codes: P2 + C3 + T31CHR

520 Cistern with Button

W: 520 D: 740 H: 1075

Codes: P2 + C2 + T31CHR

440 Cistern with Button

W: 440 D: 740 H: 1075

Codes: P2 + C4 + T31CHR

Regal Low Level WC



520 Cistern with Lever

W: 520 D: 740 H: 1075

Codes: P16 + C1 + T31CHR

440 Cistern with Lever

W: 440 D: 740 H: 1075

Codes: P16 + C3 + T31CHR

520 Cistern with Button

W: 520 D: 740 H: 1075

Codes: P16 + C2 + T31CHR

440 Cistern with Button

W: 440 D: 740 H: 1075

Codes: P16 + C4 + T31CHR

S Trap Low Level WC



520 Cistern with Lever

W: 520 D: 740 H: 1075

Codes: P19 + C1 + T31CHR

440 Cistern with Lever

W: 440 D: 740 H: 1075

Codes: P19 + C3 + T31CHR

520 Cistern with Button

W: 520 D: 740 H: 1075

Codes: P19 + C2 + T31CHR

440 Cistern with Button

W: 440 D: 740 H: 1075

Codes: P19 + C4 + T31CHR

Back entry cistern option available, see page 79

Please note: Seats sold separately

For alternative Lever and Flush Pipe finishes,
See page 80.

Standard Metallic Cistern Low Level WC

440 Cistern with Lever

W: 440 **D:** 740 **H:** 1130

Chrome: P2 + T71CHR + T31CHR

Gold: P2 + T71GOLD + T31GOLD

Br. Nickel: P2 + T71BNKL + T31BNKL



For full details on our WC ranges go to burlingtonbathrooms.com/guides/toilets

MEDIUM LEVEL

Standard Medium Level WC



520 Cistern with Lever

W: 520 D: 720 H: 1425

Codes: P5 + C1 + T33CHR

440 Cistern with Lever

W: 440 D: 720 H: 1425

Codes: P5 + C3 + T33CHR

520 Cistern with Button

W: 520 D: 720 H: 1425

Codes: P5 + C2 + T33CHR

440 Cistern with Button

W: 440 D: 720 H: 1425

Codes: P5 + C4 + T33CHR

Regal Medium Level WC



520 Cistern with Lever

W: 520 D: 720 H: 1425

Codes: P12 + C1 + T33CHR

440 Cistern with Lever

W: 440 D: 720 H: 1425

Codes: P12 + C3 + T33CHR

520 Cistern with Button

W: 520 D: 720 H: 1425

Codes: P12 + C2 + T33CHR

440 Cistern with Button

W: 440 D: 720 H: 1425

Codes: P12 + C4 + T33CHR

Rimless Medium Level WC



520 Cistern with Lever

W: 520 D: 720 H: 1425

Codes: P20 + C1 + T33CHR

440 Cistern with Lever

W: 440 D: 720 H: 1425

Codes: P20 + C3 + T33CHR

520 Cistern with Button

W: 520 D: 720 H: 1425

Codes: P20 + C2 + T33CHR

440 Cistern with Button

W: 440 D: 720 H: 1425

Codes: P20 + C4 + T33CHR

Please note: Seats sold separately



S Trap Medium Level WC

520 Cistern with Lever

W: 520 **D:** 710 **H:** 1425

Codes: P18 + C1 + T33CHR

440 Cistern with Lever

W: 440 **D:** 710 **H:** 1425

Codes: P18 + C3 + T33CHR

520 Cistern with Button

W: 520 **D:** 710 **H:** 1425

Codes: P18 + C2 + T33CHR

440 Cistern with Button

W: 440 **D:** 710 **H:** 1425

Codes: P18 + C4 + T33CHR

Back entry cistern option available, see page 79



Standard Chrome Level Medium Level WC

440 Cistern with Lever

W: 440 **D:** 730 **H:** 1425

Codes: P5 + T71CHR + T33CHR

CHOOSE YOUR PAN

Choose between Standard or Regal WCs with an option of Rimless pans available across a number of our products.

Standard

Our standard WC offers a pan that is 420mm with a box rim. A popular choice for creating a traditional look in your bathroom.

Regal

At Burlington we've created a range that's taller than average sanitaryware. Regal WC pans are 60mm higher than the standard option.

Rimless

The rimless WC is exceptionally easy to keep clean. Its powerful flush covers the entire bowl, making it the most hygienic option.

For full details on our WC ranges go to burlingtonbathrooms.com/guides/toilets

HIGH LEVEL



Standard High Level WC

520 Cistern with Dual Flush

W: 520 D: 670 H: 2380

Codes: P2 + C5 + T30CHR

520 Cistern with Single Flush

W: 520 D: 670 H: 2380

Codes: P2 + C28S + T30CHR

430 Aluminium Cistern with Dual Flush

W: 430 D: 670 H: 2380

Brushed: P2 + T58ALU + T30CHR

Black: P2 + T60BLA + T30CHR

White: P2 + T59WHI + T30CHR



Regal High Level WC

520 Cistern with Dual Flush

W: 520 D: 670 H: 2380

Codes: P16 + C5 + T30CHR

520 Cistern with Single Flush

W: 520 D: 670 H: 2380

Codes: P16 + C28S + T30CHR

430 Aluminium Cistern with Dual Flush

W: 430 D: 670 H: 2380

Brushed: P16 + T58ALU + T30CHR

Black: P16 + T60BLA + T30CHR

White: P16 + T59WHI + T30CHR



S Trap High Level WC

520 Cistern with Dual Flush

W: 520 D: 670 H: 2380

Codes: P19 + C5 + T30CHR

520 Cistern with Single Flush

W: 520 D: 670 H: 2380

Codes: P19 + C28S + T30CHR

430 Aluminium Cistern with Dual Flush

W: 440 D: 670 H: 2380

Brushed: P19 + T58ALU + T30CHR

Black: P19 + T60BLA + T30CHR

White: P19 + T59WHI + T30CHR

Back entry cistern option available, see page 79

Please note: Seats sold separately

For alternative Lever and Flush Pipe finishes,
See page 80.



High Level Metallic WC

440 Cistern with Dual Flush

W: 440 **D:** 670 **H:** 2400

Chrome: P2 + T70CHR + T30CHR

Gold: P2 + T70GOLD + T30GOLD

Br. Nickel: P2 + T70BNKL + T30BNKL

REGAL WCs

At Burlington we've created a range that's taller than average sanitaryware. Regal WC pans are 60mm higher than the standard option.

At 480mm high the taller WC pan ensures the knee angle remains at approximately 90 degrees whilst in use, which is the correct seating position. The taller WC provides a more comfortable use for taller people and the elderly whilst ensuring your WC is functional as well as beautiful too.



For full details on our WC ranges go to burlingtonbathrooms.com/guides/toilets

OTHERS



Back to Wall

Standard

W: 360 **D:** 475 **H:** 425

Code: P14

Regal

W: 370 **D:** 480 **H:** 480

Code: P15

Standard Rimless

W: 360 **D:** 480 **H:** 420

Code: P21

For concealed cisterns and flush options see page 80.



Wall Hung

W: 335 **D:** 500

Code: P10

For concealed cisterns and flush options see page 80.



Bidets

Floorstanding

W: 400 **D:** 570 **H:** 400

Code: P4

Please note: Seats sold separately

ARCADE



Arcade

Close Coupled

W: 500 D: 670 H: 885

Codes: ARC4 + ARC5

Back to Wall

W: 365 D: 520 H: 460

Code: ARC6



For full details on our WC ranges go to burlingtonbathrooms.com/guides/toilets

SEATS & ACCESSORIES



Matt White soft-close seat
Code: S45

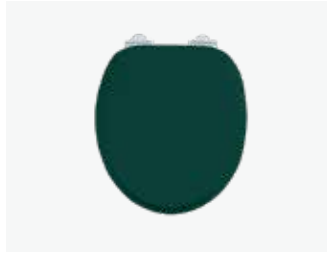

Green soft-close seat
Code: S102



Classic Grey soft-close seat
Code: S46

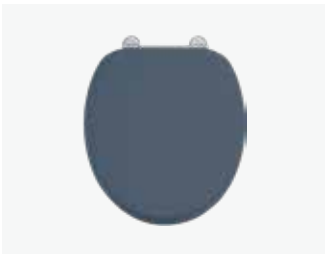

Blue soft-close seat
Code: S99

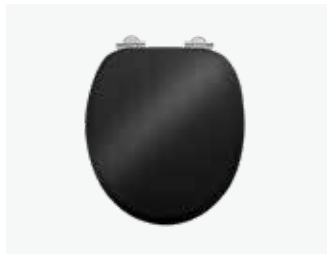

Gloss Black soft-close seat
Code: S40

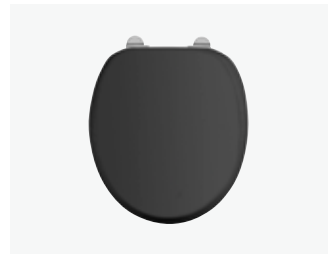

Matt Black soft-close seat
Matt Black: S48



Oak seat
Standard: S11
Soft-close: S16



Gloss Mahogany seat
Standard: S12
Soft-close: S17



White carbamide seat
Standard: S13
Soft-close: S18
Note: Not compatible with Gold and Brushed Nickel seat hinges.

Our WC seats match our furniture.
See page 100 for the full range.



Seat handles
(Sold in pairs)

Chrome: A51CHR
Gold: A51GOLD
Br. Nickel: A51BNKL



Seat hinges
(Seats supplied with Chrome hinges)

Gold: SP813
Br. Nickel: SP813BNKL



Gold cover caps for WCs
(Sold in pairs)

Please check how many cover caps are needed for the toilet you are ordering.

Code: SP387



Ceramic trap for converting
P trap to S trap

Code: C26



Straight ceramic trap

Code: C29

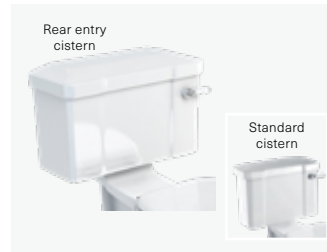

Back entry 520mm deep
lever cistern

Code: C30

WC Rear Entry Options

Burlington cisterns are available with either bottom or back entry filling for flexible installation.

If you need to fill your cistern from the back, you will need to order a C30.

(This deep cistern increases the distance from pan outlet to the wall by 20mm)



LEVER OPTIONS

Our elegant cistern levers are available in Gold or Brushed Nickel and create the perfect finishing touch to match your brassware and accessories. These levers are compatible with the below Flush Pipes and Concealed Cistern.



Gold Lever

To add a Gold Lever please order a SP390GOLD.



Brushed Nickel Lever

To add a Brushed Nickel Lever please order a SP390BNKL.



Back to Wall / Wall Hung
Concealed Cistern

W: 514 **D:** 170 **H:** 314

Code: F6CC

Gold Dual Flush Rod

Available for our high level toilets only (not available on C28S cisterns)

Code: SP391GOLD

Brushed Nickel Dual Flush Rod

Available for our high level toilets only (not available on C28S cisterns)

Code: SP391BNKL



Gold Flush Pipes

Available for our low level and high level toilets only.

Low Level: T31GOLD
High Level: T30GOLD



Brushed Nickel Flush Pipes

Available for our low level and high level toilets only.

Low Level: T31BNKL
High Level: T30BNKL



FLUSHPLATE OPTIONS



Complete your Wall Hung or Back to Wall toilet with a stunning flush plate that harmonises with any traditional style. Available in Chrome, Brushed Nickel and Gold, this flush plate can be used with any of the below Concealed Cisterns and Wall Hung Frames.



Traditional Flush Plate

W: 245 **D:** 9 **H:** 165

Chrome: BURPLATEC

Gold: BURPLATEG

Br. Nickel: BURPLATEL



Wall Hung 0.82m Support Toilet Frame

Dual flush concealed cistern and installation kit included

W: 450 **L:** 159 **H:** 820

Code: BR_WCF80X45R

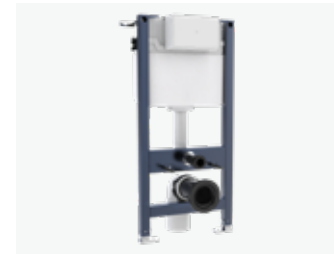

Wall Hung 0.98m Support Toilet Frame

Dual flush concealed cistern and installation kit included

W: 450 **L:** 159 **H:** 980

Code: BR_WCF98X45R



Wall Hung 1.12m Support Toilet Frame

Dual flush concealed cistern and installation kit included

W: 506 **L:** 114 **H:** 1120

Code: BR_WCF114X51R



Wall Hung 1.12m Slim Depth Support Toilet Frame

Dual flush concealed cistern and installation kit included

W: 497 **L:** 80 **H:** 1120

Code: BR_WCF114X50R



Wall Hung 1.14m Slim Depth Support Toilet Frame

Dual flush concealed cistern and installation kit included

W: 590 **L:** 110 **H:** 1140

Code: BR_WCF114X59R



Back to Wall Dual Flush Concealed Cistern

Discharge pipe and installation kit included

W: 414 **L:** 143 **H:** 387

Code: BR_WCC46X39R



Back to Wall Slimline Dual Flush Concealed Cistern

Discharge pipe and installation kit included

W: 508 **L:** 80 **H:** 550

Code: BR_WCC51X51R



RIVIERA

Riviera Close Coupled Open Back WC

Close Coupled Open Back

W: 357 **D:** 660 **H:** 820

Codes: RIV9 + RIV11 + RIV025

Includes Chrome lever
and seat.

Riviera Close Coupled Full Back To Wall WC

Close Coupled Back to Wall

W: 357 **D:** 660 **H:** 820

Codes: RIV10 + RIV11 + RIV025

Includes Chrome lever
and seat.

Riviera Back to Wall WC

Back to Wall

W: 359 **D:** 535 **H:** 420

Codes: RIV12 + RIV025

Concealed Cistern including Lever

Chrome: F6CCRIVCP

Gold: F6CCRIVGP

Includes seat.





Riviera Wall Hung WC

Wall Hung

W: 359 **D:** 535 **H:** 420

Codes: RIV13 + RIV025

Concealed Cistern including Lever

Chrome: F6CCRIVCP

Gold: F6CCRIVGP

Includes seat.

FINISHING OPTIONS

Gold finish toilet seat hinges, cistern levers and cover caps are available.

The cisterns and seats are supplied with Chrome as standard, simply add the option of Gold to match with the brassware.



Gold Lever

To add a Gold Lever please order a ARCSP6GOLD



Riviera Soft Close Seat

Seat with Chrome: RIV025
Gold Hinges: RIV030



Gold cover caps for WCs (Sold in pairs)

Please check how many cover caps are needed for the toilet you are ordering.

Code: SP387

Flushplates

Burlington now has NEW flushplate options to use with our Back to Wall or Wall Hung WCs instead of Levers.

See page 80 for the full details

For full details on our WC ranges go to burlingtonbathrooms.com/guides/toilets

GUILD



Guild Back to Wall WC

Back to Wall

W: 360 **D:** 500 **H:** 420

Chrome: GU6117CW

Gold: GU6117CW + SP390GOLD

Br. Nickel: GU6117CW + SP390BNKL



Guild Close Coupled WC

Close Coupled

W: 440 **D:** 655 **H:** 790

Chrome: GU6115CW + GU7005CW

Gold: GU6115CW + GU7005CW + SP390GOLD

Br. Nickel: GU6115CW + GU7005CW + SP390BNKL



Guild Low Level WC

Low Level

W: 440 **D:** 540 **H:** 1158

Chrome: GU6118CW + GU7005CW + T31CHR

Gold: GU6118CW + GU7005CW + T31GOLD + SP390GOLD

Br. Nickel: GU6118CW + GU7005CW + T31BNKL + SP390BNKL

Guild High Level WC

High Level

W: 520 D: 540 H: 2477

Chrome: GU6118CW + GU7002CW + T30CHR

Gold: GU6118CW + GU7002CW + T30GOLD + SP391GOLD

Br. Nickel: GU6118CW + GU7002CW + T30BNKL + SP391BNKL



FINISHING OPTIONS

Personalise your toilet and create a unified bathroom design by upgrading to Gold or Brushed Nickel toilet seat hinges or a soft close seat to match your furniture.



Seat Hinges
(Seats supplied with Chrome hinges)

Gold: GUHGG
Brushed Nickel: GUHGL



Gold cover caps for WCs
(Sold in pairs)
Please check how many cover caps are needed for the toilet you are ordering.

Code: SP387



Guild White Soft Close Seat
Code: GU6105VW



Guild Blue Soft Close Seat
Code: GU6105B



Guild Green Soft Close Seat
Code: GU6105MG



Guild Grey Soft Close Seat
Code: GU6105G



Guild Black Soft Close Seat
Code: GU6105MB

Flushplates

Burlington now has NEW flushplate options to use with our Back to Wall or Wall Hung WCs instead of Levers.

See page 80 for the full details

For full details on our WC ranges go to burlingtonbathrooms.com/guides/toilets

BASINS

From large double basins to compact cloakroom options, Burlington offers a wide range of basins with many styles and sizes perfectly formed to suit your traditional bathroom.

STYLE OPTIONS

Burlington has a wide range of Basin options. Select your style below.

Classic



The Classic collection from Burlington is beautifully formed, available in rectangular or square designs, complete with an invisible waste option.

Edwardian



The Edwardian collection is the ultimate in traditional bathrooms with structured corners and angular designs, the feel is unapologetic and proud.

Victorian



Delicate and refined, the simplicity of this basin is stunning whilst its versatility allows you to continue the style through your home and brings an air of luxury.

Contemporary



As the name suggests, the Contemporary collection is styled on the elegance of past times but with a modern day twist. Simplistic, structured lines form the basis for this striking ceramic collection.

Contemporary Upstands



The Contemporary Upstand collection offers a classic structured look with a modern twist, combining a classic upstand with the clean lines of a contemporary basin.

Cloakroom



A choice of traditionally designed cloakroom basins to achieve a consistent look throughout the home.

BASINS

ADDITIONS

Some of our washstands have the option to add additional features including a towel rack or rail.



Towel Rails



Towel Racks

REGAL

Burlington Regal pedestals and washstands are higher than standard, making them more comfortable for taller people, the elderly or those prone to back pain.

	Standard	Regal
Classic	860mm	920mm
Victorian	840mm	900mm
Edwardian	840mm	900mm
Contemporary	840mm	900mm
Washstands	840mm	900mm



GUARANTEES

*The lifetime guarantee is subject to online registration and represents the perceived lifetime of the product which is 25 years.

For full details on guarantees please visit burlingtonbathrooms.com/guarantee.

Basins

LIFETIME

Guarantee*

88

CLASSIC

90

EDWARDIAN

92

VICTORIAN

93

CONTEMPORARY

94

CONTEMPORARY UPSTANDS

96

CLOAKROOM

98

RIVIERA

CLASSIC BASINS



Classic 510mm Square Basin

With Washstand

W: 510 **D:** 450 **H:** 890

Chrome: B20* + T52CHR

Br. Nickel: B20* + T52BNKL

Available with a Regal washstand. See page 93 for more details.



Classic 650mm Rectangular Basin

With Washstand

W: 650 **D:** 575 **H:** 830

Chrome: B15* + T49ACHR

Gold: B15* + T49AGOLD

Br. Nickel: B15* + T49ABNKL

With Pedestal

W: 650 **D:** 575 **H:** 860

Codes: B15* + P6

Available with a Regal washstand. See page 93 for more details.



Classic 650mm Rectangular Basin with Invisible Overflow

With Chrome Washstand

W: 650 **D:** 575 **H:** 860

Codes: B14 + T49ACHR

Invisible Overflow & Waste

W: 74 **D:** 74 **H:** 300

Code: W9



Available with a Regal washstand. See page 93 for more details.

* Options available for 1TH, 2TH or 3TH tap holes. Please check website for full details

Our washstands are also available in a Gold or Brushed Nickel finish.



INVISIBLE OVERFLOW WASTE

Available with the Classic collection as a two tap hole configuration. The benefit of invisible overflow is that the ceramic of the beautiful basins is un-interrupted with no requirement for a plug or external waste. Simply pull the lever to drain water. Pair with the elegant and beautiful Arch basin mixer allowing you to mix hot and cold water. See page 38 for an example.

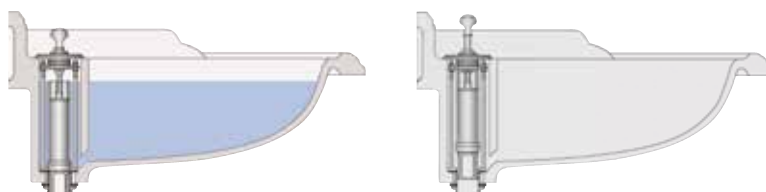

For full details on our basin ranges go to burlingtonbathrooms.com/guides/basins

EDWARDIAN BASINS

Edwardian 560mm Rectangular Basin



With Washstand

W: 560 **D:** 470 **H:** 840

Chrome: B4* + T22ACHR

Gold: B4* + T22AGOLD

Br. Nickel: B4* + T22ABNKL

With Pedestal

W: 560 **D:** 470 **H:** 840

Codes: B4* + P1

With Semi Pedestal

W: 560 **D:** 470 **H:** 840

Codes: B4** + P8

Available with a Regal washstand/pedestal. See page 93 for more details.

Edwardian 610mm Rectangular Basin



With Washstand

W: 610 **D:** 510 **H:** 840

Chrome: B5* + T23ACHR

Gold: B5* + T23AGOLD

Br. Nickel: B5* + T23ABNKL

With Pedestal

W: 610 **D:** 510 **H:** 840

Codes: B5* + P1

With Semi Pedestal

W: 610 **D:** 510 **H:** 840

Codes: B5** + P8

Available with a Regal washstand/pedestal. See page 93 for more details.

Edwardian 800mm Rectangular Basin



With Washstand

W: 800 **D:** 510 **H:** 840

Chrome: B18* + T50CHR

Gold: B18* + T50GOLD

Br. Nickel: B18* + T50BNKL

With Pedestal

W: 800 **D:** 510 **H:** 840

Codes: B18* + P6

Available with a Regal washstand/pedestal. See page 93 for more details.

* Options available for 1TH, 2TH or 3TH tap holes. Please check website for full details
 ** 3TH is not available with semi pedestals

Our washstands are also available in a Gold or Brushed Nickel finish.



Edwardian 1200mm Rectangular Basin

With Washstand

W: 1200 **D:** 510 **H:** 840

Chrome: B19* + T51CHR

Gold: B19* + T51GOLD

Br. Nickel: B19* + T51BNKL

With Pedestal

W: 1200 **D:** 510 **H:** 840

Codes: B19* + P6

Available with a Regal washstand/pedestal. See page 93 for more details.



Edwardian 1200mm Double Rectangular Basin

With Washstand

W: 1200 **D:** 510 **H:** 840

Chrome: B21* + T51CHR

Gold: B21* + T51GOLD

Br. Nickel: B21* + T51BNKL

Available with a Regal washstand/pedestal. See page 93 for more details.



Edwardian 560mm Round Basin

With Washstand

W: 560 **D:** 470 **H:** 840

Chrome: B6* + T24ACHR

Gold: B6* + T24AGOLD

Br. Nickel: B6* + T24ABNKL

With Pedestal

W: 560 **D:** 470 **H:** 840

Codes: B6* + P1

Also available with an optional towel rail. See page 92 for more information.

Available with a Regal washstand/pedestal. See page 93 for more details.

VICTORIAN BASINS



Victorian 560mm Rectangular Basin

With Washstand

W: 560 **D:** 470 **H:** 840

Chrome: B2* + T22ACHR

Gold: B2* + T22AGOLD

Br. Nickel: B2* + T22ABNKL

With Pedestal

W: 560 **D:** 470 **H:** 840

Codes: B2* + P1

With Semi Pedestal

W: 560 **D:** 470 **H:** 840

Codes: B2** + P8

Available with a Regal washstand/pedestal. See right hand side for more details.



Victorian 610mm Rectangular Basin

With Washstand

W: 610 **D:** 510 **H:** 840

Chrome: B3* + T23ACHR

Gold: B3* + T23AGOLD

Br. Nickel: B3* + T23ABNKL

With Pedestal

W: 610 **D:** 510 **H:** 840

Codes: B3* + P1

With Semi Pedestal

W: 610 **D:** 510 **H:** 840

Codes: B3** + P8

Available with a Regal washstand/pedestal. See right hand side for more details.

ADDITIONAL CHOICES

Optional towel racks and rails are available for adding extra storage or space for towels in your bathroom. Towel racks are only compatible with washstands T22A and T23A. Towel rails can be added to Victorian, Edwardian and Contemporary Upstand basins.

Towel Rails

Rectangular Basins
560 Basin: T1CHR
610 Basin: T3CHR

Round Basins
560 Basin: T4CHR



Towel Racks

For 560mm and 580mm Washstands
Chrome: T22A_S
Gold: T22A_SGOLD
Br. Nickel: T22A_SBNKL

For 610mm Washstands
Chrome: T23A_S
Gold: T23A_SGOLD
Br. Nickel: T23A_SBNKL



* Options available for 1TH, 2TH or 3TH tap holes. Please check website for full details
 ** 3TH is not available with semi pedestals

CONTEMPORARY BASINS



Contemporary 580mm Rectangular Basin

With Washstand

W: 580 **D:** 470 **H:** 840

Chrome: B1* + T22ACHR

Gold: B1* + T22AGOLD

Br. Nickel: B1* + T22ABNKL

With Pedestal

W: 580 **D:** 470 **H:** 840

Codes: B1* + P1

With Semi Pedestal

W: 580 **D:** 470 **H:** 840

Codes: B1** + P8

Available with a Regal washstand/pedestal. See below for more details.



Semi-recessed Basins

540 Countertop

W: 540 **D:** 425

Code: B13*

580 Semi-recessed

W: 575 **D:** 470

Code: B12*

REGAL OPTIONS

Burlington Regal pedestals and washstands are higher than standard, making them more comfortable for taller people, the elderly or those prone to back pain.

Washstands

To order a regal washstand choose from a T62, T62 GOLD or a T62 BNKL depending on the chosen finish of your washstand.

Chrome
Code: T62

Gold
Code: T62GOLD

Br. Nickel
Code: T62BNKL

Pedestals

To order a regal pedestal select a P9. The Regal pedestal is compatible with the B1, B2, B3, B4, B5 and B6 basins only.

Regal Pedestal
Code: P9

For full details on our basin ranges go to burlingtonbathrooms.com/guides/basins

CONTEMPORARY UPSTAND BASINS



Contemporary Upstand 560mm Rectangular Basin

With Washstand

W: 560 **D:** 470 **H:** 840

Chrome: B1UP* + T22ACHR

Gold: B1UP* + T22AGOLD

Br. Nickel: B1UP* + T22ABNKL

With Pedestal

W: 560 **D:** 470 **H:** 840

Codes: B1UP* + P6

Available with a Regal washstand/pedestal. See page 93 for more details.



Contemporary Upstand 610mm Rectangular Basin

With Washstand

W: 610 **D:** 510 **H:** 840

Chrome: B2UP* + T23ACHR

Gold: B2UP* + T23AGOLD

Br. Nickel: B2UP* + T23ABNKL

With Pedestal

W: 610 **D:** 510 **H:** 840

Codes: B2UP* + P6

Available with a Regal washstand/pedestal. See page 93 for more details.

ADDITIONAL CHOICES

Optional towel racks and rails are available for adding extra storage or space for towels in your bathroom. Towel racks are only compatible with washstands T22A and T23A. Towel rails can be added to Victorian, Edwardian and Contemporary Upstand basins.

Towel Rails

Rectangular Basins
560 Basin: T1CHR
610 Basin: T3CHR

Round Basins
560 Basin: T4CHR



Towel Racks

For 560mm and 580mm Washstands
Chrome: T22A_S
Gold: T22A_SGOLD
Br. Nickel: T22A_SBNKL

For 610mm Washstands
Chrome: T23A_S
Gold: T23A_SGOLD
Br. Nickel: T23A_SBNKL



* Options available for 1TH, 2TH or 3TH tap holes. Please check website for full details
 ** 3TH is not available with semi pedestals

Our washstands are also available in a Gold or Brushed Nickel finish.



For full details on our basin ranges go to burlingtonbathrooms.com/guides/basins

CLOAKROOM BASINS



Edwardian Cloakroom 515mm Basin
with Washstands

With Washstand

W: 515 **D:** 308 **H:** 825

Chrome: B8* + T21ACHR

Gold: B8* + T21AGOLD

Br. Nickel: B8* + T21ABNKL

Available with a Regal washstand. See below for more details.



Edwardian

Curved

Arcade

Corner

Cloakroom Basins

Edwardian 515

W: 515 **D:** 308

Code: B8*

Curved 505

W: 505 **D:** 255

Code: P13*

Arcade 500

W: 500 **D:** 400

Code: ARC500*

Corner 600

W: 600 **D:** 450

Code: B10

REGAL OPTIONS

Burlington Regal pedestals and washstands are higher than standard, making them more comfortable for taller people, the elderly or those prone to back pain.

Washstands

To order a regal washstand choose from a T62, T62GOLD or a T62BNKL depending on the chosen finish of your washstand.

Chrome
Code: T62

Gold
Code: T62GOLD

Br. Nickel
Code: T62BNKL

Pedestals

To order a regal pedestal select a P9. The Regal pedestal is compatible with the B1, B2, B3, B4, B5 and B6 basins only.

Regal Pedestal
Code: P9

* Options available for 1TH, 2TH or 3TH tap holes. Please check website for full details

Our washstands are also available in a Gold or Brushed Nickel finish.



For full details on our basin ranges go to burlingtonbathrooms.com/guides/basins

RIVIERA BASINS

Riviera 580mm D Shaped Basin



With Pedestal

W: 580 **D:** 470 **H:** 847

Codes: RIV3* + RIV6

With Semi Pedestal

W: 580 **D:** 470 **H:** 847

Codes: RIV3** + RIV7

Riviera 650mm D Shaped Basin



With Pedestal

W: 650 **D:** 470 **H:** 847

Codes: RIV4* + RIV6

With Semi Pedestal

W: 650 **D:** 470 **H:** 847

Codes: RIV4** + RIV7

For full details on our basin ranges go to burlingtonbathrooms.com/guides/basins

* Options available for NTH, 1TH, 2TH or 3TH tap holes. Please check website for full details
** 3TH is not available with semi pedestals



Riviera 580mm Square Shaped Basin

With Pedestal

W: 580 **D:** 470 **H:** 847

Codes: RIV1* + RIV6

With Semi Pedestal

W: 580 **D:** 470 **H:** 847

Codes: RIV1** + RIV7



Riviera 650mm Square Shaped Basin

With Pedestal

W: 650 **D:** 470 **H:** 847

Codes: RIV2* + RIV6

With Semi Pedestal

W: 650 **D:** 470 **H:** 847

Codes: RIV2** + RIV7



Riviera Cloakroom Basin

450 Square Cloakroom

W: 450 **D:** 320

Codes: RIV8_2TH

The Cloakroom basin is 2 taphole only and is not designed for use with either pedestal.

FURNITURE

A range of beautifully traditional furniture solutions to add classic style and sophisticated British elegance to your bathroom. Choose from freestanding in either square or curved design or cloakroom options to create the most functional space to suit your individual needs.

KEY FEATURES

Our furniture solutions are made from the finest materials and offer innovative features and smart details. Perfectly suited for the bathroom environment.



Freestanding



Chalfont



Riviera



The plinths of the freestanding furniture are crafted from a waterproof high density material - providing extra protection and giving peace of mind that wet floors will not lead to damage.



Available in 4 sizes and 3 colours with the design option to have wall hung or floor standing by using additional legs available in wood with matching paint finishes or in brass with a Chrome, Gold or Brushed Nickel finish to compliment the Burlington brassware ranges.



Available as floor-standing in 2 sizes with three handle options available in Chrome, Gold or Brushed Nickel finishes.



Each of our Classic furniture pieces are prepared with 5 layers of primer featuring UV stabilisation to minimise colour fading from exposure to sunlight. The painted top coat is then applied for a glorious depth of colour.



All of our Chalfont furniture pieces have a high quality paint finish and are prepared with 3 layers of primer featuring UV stabilisation to minimise colour fading from exposure to sunlight. Followed by 2 layers of top coat for a glorious depth of colour.



Made from materials specifically selected to withstand the rigours of life in the bathroom where temperature and humidity can vary widely.



Each part is coated with five layers of primer, before the final coating is applied; this top coat is UV-resistant to reduce the effects of exposure to bright sunlight.



Chalfont furniture units are finished with an integrated ceramic basin featuring a beautiful traditional design that perfectly complements the curvature of the unit. These basins are hard-wearing, resistant to day-to-day wear and tear and available with either 1 or 3 tap holes to accommodate your preferred brassware.



Riviera vanity units are supplied fully assembled for simple installation, with adjustable feet to ensure stability and protect them from wet floors.

FURNITURE

102
CLOAKROOM

103
FREESTANDING

106
MIRRORS

107
BATH

110
CHALFONT

112
RIVIERA

GUARANTEES

*For full details on guarantees please visit
burlingtonbathrooms.com/guarantee.

Furniture

10
YEAR

Guarantee*

FREESTANDING FURNITURE

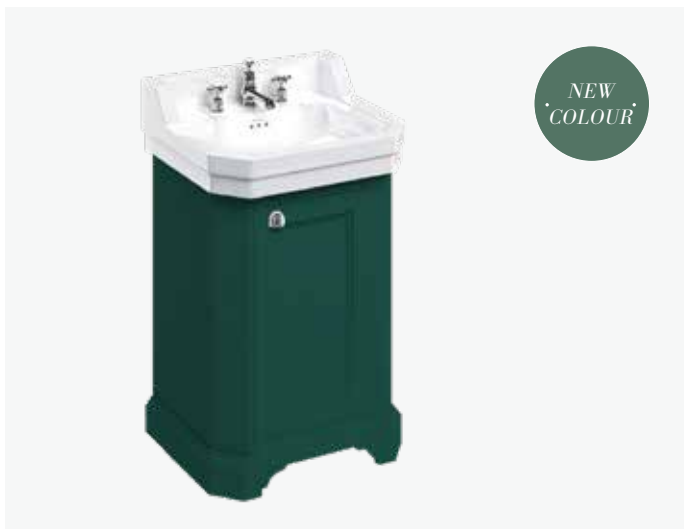

Edwardian 560mm Basin & Freestanding Rectangular Cloakroom Vanity Unit

W: 560 D: 470 H: 927

Matt White: FC12W + B4

Classic Grey: FC12G + B4

Blue: FC12B + B4

Matt Green: FC12MG + B4

Matt Black: FC12BM + B4

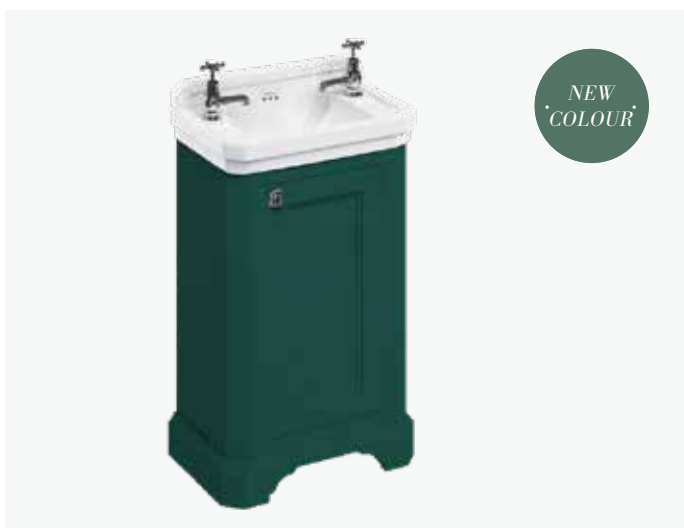

Edwardian Cloakroom Basin & Freestanding Rectangular Cloakroom Vanity Unit

W: 512 D: 310 H: 905

Matt White: FC11W + B8

Classic Grey: FC11G + B8

Blue: FC11B + B8

Matt Green: FC11MG + B8

Matt Black: FC11BM + B8

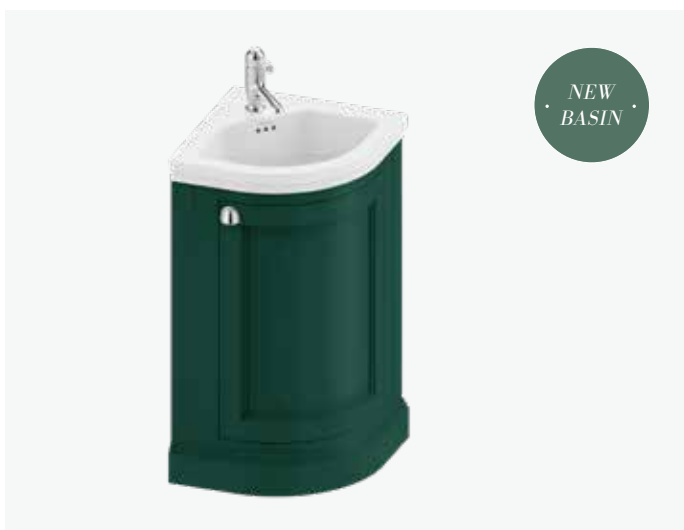

Corner Basin & Freestanding Corner Cloakroom Vanity Unit

W: 430 D: 430 H: 840

Matt White: FC7W + FC7CBC

Classic Grey: FC7G + FC7CBC

Matt Green: FC7MG + FC7CBC

Matt Black: FC7BM + FC7CBC

Right hand only.
Handles are supplied fitted.

Chrome handles included with the furniture. To purchase alternative finishes please use the codes: **Br. Nickel:** A56BNKL **Gold:** A56GOLD

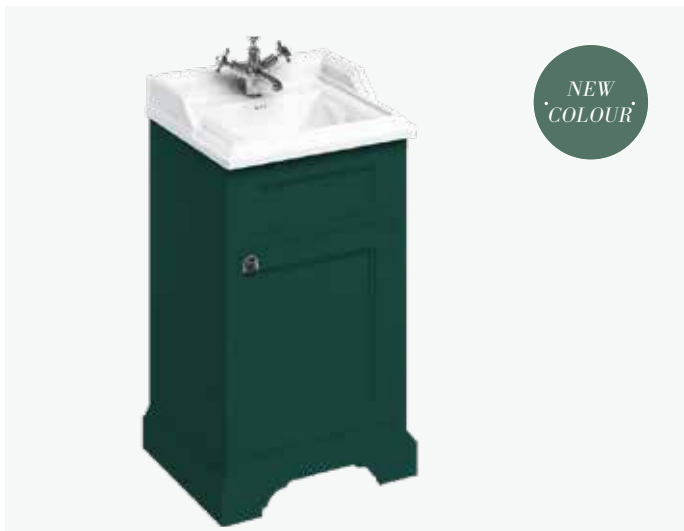

Classic 510mm Basin & Freestanding 500mm Square Cloakroom Vanity Unit

W: 510 **D:** 450 **H:** 915

Matt White: FC8W + B20

Classic Grey: FC8G + B20

Blue: FC8B + B20

Matt Green: FC8MG + B20

Matt Black: FC8BM + B20



Freestanding 650 Curved Vanity Unit With Doors & Minerva® Worktops

W: 650 **D:** 530 **H:** 1000

Matt White: FC5W

Classic Grey: FC5G

Blue: FC5B

Matt Green: FC5MG

Matt Black: FC5BM

Now choose a worktop from the below



White: BW65



Carrara White: BC65



Freestanding 750 Vanity Unit With Doors & Minerva® Worktops

W: 790 **D:** 550 **H:** 1000

Matt White: FC13W

Classic Grey: FC13G

Blue: FC13B

Matt Green: FC13MG

Matt Black: FC13BM

Now choose a worktop from the below



White: BW75



Carrara White: BC75

*Please check the product to see the colours available.

FREESTANDING FURNITURE



Freestanding 650 Vanity Unit & Classic 650 Basin
for Standard Waste & Overflow

With Doors

W: 670 **D:** 580 **H:** 930

Matt White: FF8W + B15

Classic Grey: FF8G + B15

Blue: FF8B + B15

Matt Green: FF8MG + B15

Matt Black: FF8BM + B15

With Drawers

W: 670 **D:** 580 **H:** 930

Matt White: FF9W + B15

Classic Grey: FF9G + B15

Matt Green: FF9MG + B15



Freestanding 650 Vanity Unit & Classic 650 Basin
for Integrated Waste & Overflow

With Doors

W: 670 **D:** 580 **H:** 930

Matt White: FF8W + B14

Classic Grey: FF8G + B14

Blue: FF8B + B14

Matt Green: FF8MG + B14

Matt Black: FF8BM + B14

With Drawers

W: 670 **D:** 580 **H:** 930

Matt White: FF9W + B14

Classic Grey: FF9G + B14

Matt Green: FF9MG + B14



Freestanding 650 Vanity Unit & Minerva®
Worktops with Vanity Bowl

With Doors

W: 670 **D:** 580 **H:** 850-930

Matt White: FF8W

Classic Grey: FF8G

Blue: FF8B

Matt Green: FF8MG

Matt Black: FF8BM

With Drawers

W: 670 **D:** 580 **H:** 850-930

Matt White: FF9W

Classic Grey: FF9G

Matt Green: FF9MG

Now choose a worktop from the below



White: BW66



Carrara White: BC66

Chrome handles included with the furniture. To purchase alternative finishes please use the codes: **Br. Nickel:** A56BNKL **Gold:** A56GOLD



Freestanding 1300 Vanity Unit With Doors & Minerva® Worktops with Double Vanity Bowl

With Doors

W: 1300 **D:** 550 **H:** 850-930

Matt White: FC9W
Classic Grey: FC9G
Blue: FC9B
Matt Green: FC9MG
Matt Black: FC9BM

With Drawers

W: 1300 **D:** 550 **H:** 850-930

Matt White: FC10W
Matt Green: FC10MG
Matt Black: FC10BM

Now choose a worktop from the below



White: BW12



Carrara White: BC12



Freestanding 1340 Curved Vanity Unit With Doors & Minerva® Worktops with Vanity Bowl

With Doors

W: 1340 **D:** 550 **H:** 850-930

Matt White: FC1W
Classic Grey: FC1G
Blue: FC1B
Matt Green: FC1MG
Matt Black: FC1BM

With Drawers

W: 1340 **D:** 550 **H:** 850-930

Matt White: FC4W
Matt Green: FC4MG

Now choose a worktop from the below



White: BW13



Carrara White: BC13

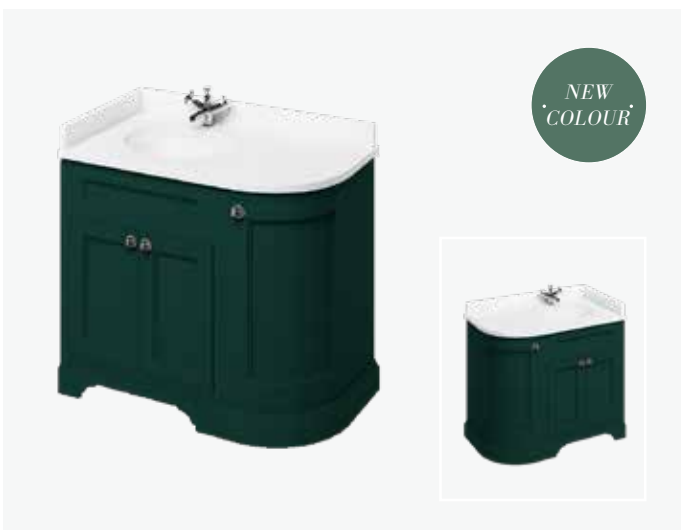

Freestanding 980 Curved Vanity Unit With Doors & Minerva® Worktops with Vanity Bowl

Left Handed

W: 980 **D:** 550 **H:** 850-930

Matt White: FC2W
Matt Green: FC2MG
Matt Black: FC2BM

Right Handed

W: 980 **D:** 550 **H:** 850-930

Matt White: FC3W
Matt Green: FC3MG
Matt Black: FC3BM

Now choose a worktop from the below



White:
 BW98L/R



Carrara White:
 BC98L/R

*Please check the product to see the colours available.

MIRRORED FURNITURE



1200 Minerva® Worktops

Minerva® White

Code: BW305

Minerva® Carrara White

Code: BC305

Other worktops available see page 106

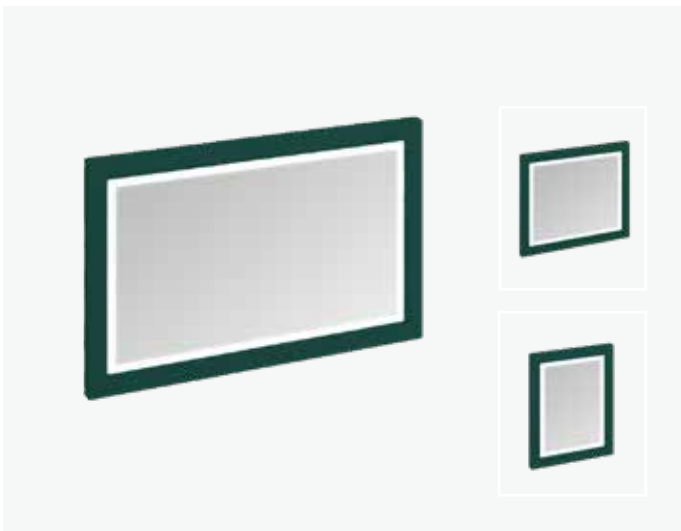

Framed Mirror with LED Illuminations

1200 Mirror

W: 1200 **D:** 40 **H:** 750

Matt White: M12MW

Blue: M12MB

Matt Green: M12MMG

900 Mirror

W: 900 **D:** 40 **H:** 750

Matt White: M9MW

Classic Grey: M9MG

Matt Green: M9MMG

600 Mirror

W: 600 **D:** 40 **H:** 750

Matt White: M6MW

Blue: M6MB

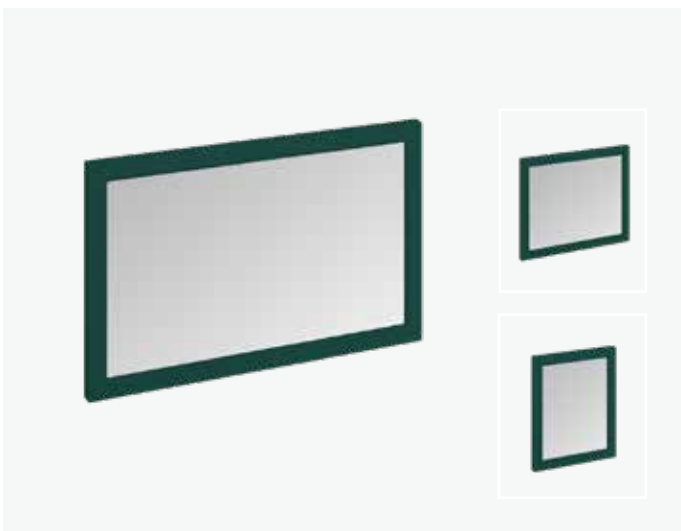

Framed Mirror

1200 Mirror

W: 1200 **D:** 40 **H:** 750

Matt White: M12OW

Classic Grey: M12OG

Matt Green: M12OMG

900 Mirror

W: 900 **D:** 40 **H:** 750

Matt White: M9OW

Classic Grey: M9OG

Matt Green: M9OMG

600 Mirror

W: 600 **D:** 40 **H:** 750

Matt White: M6OW

Classic Grey: M6OG

Matt Green: M6OMG



600 Mirrored Cabinet

W: 600 **D:** 152 **H:** 750

Classic Grey: SM6015G

Blue: SM6015B

Matt Green: SM6015MG



Arundel Bath with Panels

1700 x 700

W: 700 **D:** 1700 **H:** 595

Matt White:

E28 + E24FW + E25EW

Matt Green:

E28 + E24FMG + E25EMG

1700 x 750

W: 750 **D:** 1700 **H:** 595

Matt White:

E30 + E24FW + E26EW

Matt Green:

E30 + E24FMG + E26EMG

*Please check the product to see the colours available.

MINERVA WORKTOPS

Minerva worktops offer superior strength with a beautiful finish. Available from stock in either White or Carrara White. Why not choose from our other 11 unique decor options, available to order with longer custom delivery times (4 - 5 weeks) for the ultimate personalised look. Please ask your retailer for details on the price of the 11 additional finishes.



White



Carrara White



Ice Blue



Desert Rock



Fossil



Peak Stone



Nimbus Grey



Amazonia Brown



Ice Crystal



Copper Fleck



Sparkling White



Caramel Crunch



Grey Crystal



Minerva® Care Kit

Code: BCARE



Minerva® Joint Kit

White: MVWH
Carrara White: MVCA

Minerva Basins

Minerva basins fit perfectly with your chosen furniture unit. Should you opt for a fitted furniture look, a Minerva worktop can be chosen to fit the length of your furniture units.

Tap holes

Minerva® worktops are supplied with an integrated bowl with overflow, and no tap holes. Tap holes are drilled by the installer in the required position and configuration. A template is provided with the Minerva® tops indicating tap hole positions and sizes.

Routine Cleaning

Minerva® does not require any specialist cleaning regimes, most dirt will easily wipe off with a damp cloth and soapy water. The work surface should then be rinsed with clean water and wiped dry. Persistent marks can be removed by using a mild abrasive cleaner, but harsh scouring powders should be avoided.

Staining

Minerva®, unlike marble and granite, is not porous and will resist most household chemicals including alcohol and cosmetics, however, some chemicals and strong dyes can cause damage and discolouration. If spillage occurs, wipe off immediately and rinse the area thoroughly.

Minerva® Care Kit

To restore your Minerva® work top to its original best use the Care Kit to buff out all tiny scratches and scuffs. The kit contains all the sanding / buffing materials and liquids required.

PAINT YOUR OWN

Should you wish, our Matt White furniture is supplied ready for you to paint, so you can transform your entire bathroom into your individual colour scheme. We've chosen some Farrow & Ball colours as suggestions displayed below. We recommend using a water based primer before an egg shell paint finish for the best effect.

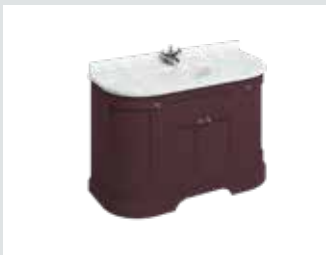

Brinjal



Incarnadine



Tanner's Brown



Red Earth



Cook's Blue



Cinder Rose



Oxford Stone



Dayroom Yellow

For full details on our furniture ranges go to burlingtonbathrooms.com/guides/furniture

CHALFONT

550 Unit with Drawer & Ceramic Small Basin



With Matching Legs

W: 525 **D:** 458 **H:** 840

Matt Black:
CH55MB + CH0551SCW +
CHLEGMB

Classic Grey:
CH55G + CH0551SCW +
CHLEGG

Blue:
CH55B + CH0551SCW + CHLEGB

Wall Hung

W: 525 **D:** 458 **H:** 840

Matt Black:
CH55MB + CH0551SCW

Classic Grey:
CH55G + CH0551SCW

Blue:
CH55B + CH0551SCW

These codes are for 1TH basins. If you would prefer a 3TH basin
replace the code CH0551SCW with the code CH0553SCW.

650 Unit with Drawer & Ceramic Medium Basin



With Matching Legs

W: 625 **D:** 458 **H:** 840

Matt Black:
CH65MB + CH0651SCW +
CHLEGMB

Classic Grey:
CH65G + CH0651SCW +
CHLEGG

Blue:
CH65B + CH0651SCW + CHLEGB

Wall Hung

W: 625 **D:** 458 **H:** 840

Matt Black:
CH65MB + CH0651SCW

Classic Grey:
CH65G + CH0651SCW

Blue:
CH65B + CH0651SCW

These codes are for 1TH basins. If you would prefer a 3TH basin
replace the code CH0651SCW with the code CH0653SCW.

750 Unit with Drawer & Ceramic Large Basin



With Matching Legs

W: 725 **D:** 458 **H:** 840

Matt Black:
CH75MB + CH0751SCW +
CHLEGMB

Classic Grey:
CH75G + CH0751SCW +
CHLEGG

Blue:
CH75B + CH0751SCW + CHLEGB

Wall Hung

W: 725 **D:** 458 **H:** 840

Matt Black:
CH75MB + CH0751SCW

Classic Grey:
CH75G + CH0751SCW

Blue:
CH75B + CH0751SCW

These codes are for 1TH basins. If you would prefer a 3TH basin
replace the code CH0751SCW with the code CH0753SCW.



1000 Unit with Drawer &
Ceramic Double Basin

With Matching Legs

W: 525 D: 458 H: 840

Matt Black:

CH100MB + CH1001SCW +
CHLEGB

Classic Grey:

CH100G + CH1001SCW +
CHLEGG

Blue:

CH100B + CH1001SCW + CHLEGB

Wall Hung

W: 525 D: 458 H: 840

Matt Black:

CH100MB + CH1001SCW

Classic Grey:

CH100G + CH1001SCW

Blue:

CH100B + CH1001SCW

These codes are for 1TH basins. If you would prefer a 3TH basin
replace the code CH1001SCW with the code CH1003SCW.

ADDITIONAL CHOICES

Our Chalfont furniture range is supplied without legs or handles allowing you to fully customise your furniture to the look you desire.
To add these, please select from the options below.



Handles

Our beautiful matching handles are available in 3 finishes allowing you to match your brassware and furniture unit perfectly. Use the codes below to order. Please note these are sold as singles.

Chrome: CHKCHR

Gold: CHKGOLD

Br. Nickel: CHKBNKL



Additional Legs

As well as having legs in the matching furniture colour we also offer 3 additional finishes with a slightly different design which are sold in pairs. If you would like these legs instead please use the codes below:

Chrome: CHLEGCHR

Gold: CHLEGGOLD

Br. Nickel: CHLEGBNKL



Natural Stone Basins

We also have another range of basins that match perfectly with our chalfont furniture. To order ones of these instead please replace the basin codes (e.g. CH0551SCW) with the below:

Small: B7E

Medium: B8E

Large: B9E

Double: B10DE

For full details on our Chalfont range go to burlingtonbathrooms.com/collection/chalfont

RIVIERA



580 Riviera Unit with Basin

580 Vanity Unit

W: 580 **D:** 470 **H:** 880

Matt White:
RIVF580W + RIV1*

Matt Blue:
RIVF580B + RIV1*

Matt Black:
RIVF580BM + RIV1*



650 Riviera Unit with Basin

650 Vanity Unit

W: 650 **D:** 470 **H:** 880

Matt White:
RIVF650W + RIV2*

Matt Blue:
RIVF650B + RIV2*

Matt Black:
RIVF650BM + RIV2*

HANDLE CHOICES

Our Riviera furniture range comes with the choice of three Art Deco inspired handle designs available in a selection of traditional finishes. Riviera units are supplied **without** handles so one of the following must be ordered to make this product functional.

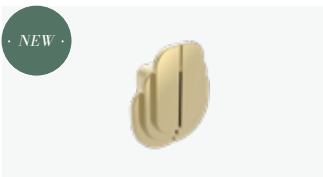

Tier Handles

Please note these are sold as a set of 2.

Chrome: RIVF12C

Gold: RIVF12G

Brushed Nickel: RIVF12BN



Ribbon Handles

Please note these are sold as a set of 2.

Chrome: RIVF13C

Gold: RIVF13G

Brushed Nickel: RIVF13BN



Square Handles

Please note these are sold as a set of 2.

Chrome: RIVF11C

Gold: RIVF11

Furniture
Colours:



*NEW
COLOUR*

For full details on our Riviera range go to burlingtonbathrooms.com/riviera

BATHS

Beautiful freestanding baths in a range of designs crafted with either TSFR (twin skinned fibre re-inforced acrylic) for superior strength or ClearStone for the epitome of luxury. Choose from soaking tubs, elegant roll top baths, single or double-ended or showering baths for flexibility of use.

BATH FEET

Choose from five leg designs in three finishes on page 121.



Claw



Arc



Classic



Traditional



Classical

PAINTING YOUR BATH

The exterior can be primed and painted. If you wish to paint yours then please note this is only possible on TSFR baths. You should seek advice from the paint manufacturer for suitable primers and processes.



BATHS

116
FREESTANDING

122
SHOWERING

123
ACCESSORIES

GUARANTEES

*For full details on guarantees please visit
burlingtonbathrooms.com/guarantee.





ADMIRAL

Double Ended Bath

1650 Bath

L: 1640 W: 705 H: 710

Code: ET5C

1800 Bath

L: 1775 W: 890 H: 750

Code: ET6C

Weight empty

1650 - 48kg

1800 - 60kg

Displaced capacity

1650 - 99L

1800 - 175L

Material

Acrylic

Tap hole options

Not suitable for rim-mounted taps

Overflow

Pre-drilled

Compatible wastes

CW3, W4, CW6



FLORENZA

Double Ended Bath

1800 Bath

L: 1828 W: 864 H: 569

Code: N23CS

Weight empty

93kg

Displaced capacity

230L

Material

ClearStone

Tap hole options

Undrilled

Overflow

Undrilled

Compatible wastes

CW3, CW2



BRINDLEY

Double Ended Bath

1700 Bath

L: 1700 W: 750 H: 620

Code: E5E12

Weight empty

36kg

Displaced capacity

180L

Material

Acrylic

Tap hole options

Not suitable for rim-mounted taps

Overflow

Supplied with template, undrilled

Compatible wastes

CW2, W3



LONDON ROUND

Double Ended Bath

1800 Bath

L: 1800 W: 850 H: 640

Code: E18

Weight empty

52kg

Displaced capacity

200L

Material

Acrylic

Tap hole options

Not suitable for rim-mounted taps

Overflow

Pre-drilled

Compatible wastes

Pre fitted



ARUNDEL

Single Ended

700 Bath

L: 1700 W: 700 H: 580

Code: E28

750 Bath

L: 1700 W: 750 H: 580

Code: E30

700 End Panels

W: 700 H: 540

700: E25E*

750 End Panels

W: 750 H: 540

750: E26E*

Side Panel

L: 1700 H: 540

Code: E24F*

Replace * with either W/MG depending on what colour panels you would like.

Weight empty

700 - 24kg

750 - 25kg

Displaced capacity

700 - 108L

750 - 125L

Material

Acrylic with
Cleargreen
reinforcement

Tap hole options

Undrilled

Overflow

Pre-drilled

Compatible wastes

W3

Compatible

bathscreens

See page 121



ARUNDEL

Double Ended

700 Bath

L: 1700 W: 700 H: 580

Code: E31

750 Bath

L: 1700 W: 750 H: 580

Code: E32

700 End Panels

W: 700 H: 540

700: E25E*

750 End Panels

W: 750 H: 540

750: E26E*

Side Panel

L: 1700 H: 540

Code: E24F*

Replace * with either W/G/MG depending on what colour panels you would like.

Weight empty

700 - 24kg

750 - 25kg

Displaced capacity

700 - 108L

750 - 125L

Material

Acrylic with
Cleargreen
reinforcement

Tap hole options

Undrilled

Overflow

Pre-drilled

Compatible wastes

W3

Compatible

bathscreens

See page 121



EMPEROR

Slipper Bath

1500 Bath

L: 1530 **W:** 725 **H:** 780

Code: ET13B

Weight empty

38kg

Displaced capacity

242L

Material

Acrylic

Tap hole options

Not suitable for rim-mounted taps

Overflow

Supplied with template, undrilled

Compatible wastes

CW2, CW3, W4, CW6, W21



AVANTGARDE

Back to Wall Bath

1700 Bath

L: 1700 **W:** 750 **H:** 630

Code: T12D

Feet - Shown With

Code: L2B

Weight empty

43kg

Displaced capacity

158L

Material

TSFR Double Acrylic

Tap hole options

0, 1, 2 (supplied with template, undrilled)

Overflow

Supplied with template, undrilled

Compatible wastes

CW2, CW3, W4, CW6, W21

Compatible feet

See page 123



BATEAU

Double Ended Bath

1700 Bath

L: 1640 **W:** 700 **H:** 720

Code: T10F

Feet - Shown With

Code: L2C

Note

The Bateau bath comes in a white finish. The exterior can be primed and painted. The photograph shows the bath in Fired Earth Carbon Blue. If you wish to paint yours then please note this is only possible on TSFR baths. You should seek advice from the paint manufacturer for suitable primers and processes.

Weight empty

42kg

Displaced capacity

169L

Material

TSFR Double
Acrylic

Tap hole options

Not suitable for rim-mounted taps

Overflow

Pre-drilled

Compatible wastes

CW3, W4, CW6, W21

Compatible feet

See page 123



WINDSOR

Double Ended Bath

1500 Bath

L: 1500 **W:** 750 **H:** 630

Code: E4

1700 Bath

L: 1700 **W:** 750 **H:** 620

Code: E3

Feet - Shown With

Code: L1C

Weight empty

1500 - 45kg
1700 - 45kg

Displaced capacity

1500 - 115L
1700 - 130L

Material

TSFR Double
Acrylic

Tap hole options

0, 1, 2 (supplied with template, undrilled)

Overflow

Supplied with template, undrilled

Compatible wastes

CW2, CW3, W4, W21

Compatible feet

See page 123



BUCKINGHAM

Slipper Bath

1500 Bath

L: 1530 W: 740 H: 620

Code: E6

Weight empty

39kg

Displaced capacity

85L

Material

TSFR Double
Acrylic

Tap hole options

0, 1, 2 (supplied
with template,
undrilled)

Overflow

Supplied with
template, undrilled

Compatible wastes

CW2, CW3, W4,
W21

Compatible feet

See page 123



HAREWOOD

Slipper Bath

1700 Bath

L: 1690 W: 730 H: 770

Code: E1

Feet - Shown With

Code: E11CHR

Weight empty

48kg

Displaced capacity

125L

Material

TSFR Double
Acrylic

Tap hole options

0, 1, 2 (supplied
with template,
undrilled)

Overflow

Supplied with
template, undrilled

Compatible wastes

CW2, CW3, W4,
W21

Compatible feet

See page 123



BLENHEIM

Single Ended Bath

1700 Bath

L: 1690 W: 750 H: 640

Code: E2

Feet - Shown With

Code: E10CHR

Weight empty
45kg

Displaced capacity
115L

Material
TSFR Double
Acrylic

Tap hole options
0, 1, 2 (supplied
with template,
undrilled)

Overflow
Supplied with
template,
undrilled

Compatible wastes
CW2, CW3, W4,
W21

Compatible feet
See page 123



HAMPTON

Showering Bath

1500 Bath

L: 1500 W: 750 H: 630

Left Handed: E20
Right Handed: E21

1700 Bath

L: 1700 W: 750 H: 620

Left Handed: E13
Right Handed: E14

Feet - Shown With

Code: L3C

Weight empty
1500 - 37kg
1700 - 46kg

Displaced capacity
1500 - 105L
1700 - 138L

Material
TSFR double acrylic
skin with solid core

Tap hole options
0, 1, 2 (supplied
with template,
undrilled)

Overflow
Supplied with
template, undrilled

Compatible wastes
W4

**Compatible
bathscreens**
See page 123

Compatible feet
See page 123



BATHSCREENS

Classique Bathscreen

Classique bathscreen

W: 850 **H:** 1450

Chrome: CQBSSC0850

Gold: CQBSGC0850

Br. Nickel: CQBSLC0850

Optional Finial

1850 Style Finial

Chrome: CQ1850PRFNC

Gold: CQ1850PRFNG

Br. Nickel: CQ1850PRFNL



1909 Style Finial

Chrome: CQ1909PRFNC

Gold: CQ1909PRFNG

Br. Nickel: CQ1909PRFNL



Match with our **NEW**
Classique shower enclosures on Page 144



Claw Feet

Chrome: L1C

White: L1W

Black: L1B

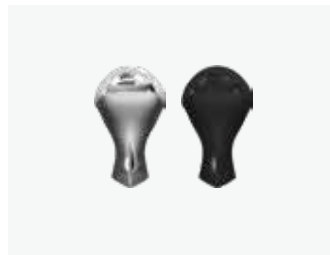

Arc Feet

Chrome: L2C

Black: L2B

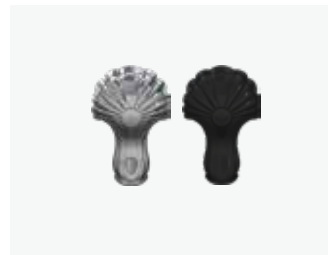

Classic Feet

Chrome: L3C

Black: L3B



Traditional Feet

Chrome: E11CHR

White: E11WHI

Black: E11BLA

Gold: E11GOLD

Br. Nickel: E11BNKL



Classical Feet

Chrome: E10CHR

White: E10WHI

Black: E10BLA



Stand pipes including horizontal support bar

Chrome: W7

Gold: W7GOLD

Br. Nickel: W7BNKL

Use with baths where fittings are not rim or wall-mounted. These can be used with deck-mounted taps only (excluding Guild, Riviera and Stafford).



Decorative shrouds

Chrome: W6

Gold: W6GOLD

Br. Nickel: W6BNKL

Use with baths with rim-mounted fittings and can be used with deck-mounted taps. Decorative only. (excluding Guild, Riviera and Stafford).

BRASSWARE

Burlington brassware can be customised with a choice of tap heads; Claremont and Kensington and a choice of finishes.

We supply every tap with two Neoperl devices: A flow straightener, which is for use with low water pressures and an aerator, which is for use with high water pressures.

KEY FEATURES

Burlington brassware products have a range of key features across basin and bath taps, shown below.



Swivelling Spouts

All our bath fillers and bath shower mixer spouts swivel - so you don't have the spout in your way when you shower.



Angled Mixers

All our bath shower mixers are available in an 'angled' version.

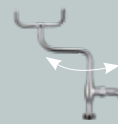

S Adjuster

The S adjuster allows the telephone handset to be positioned over the bath. The bath shower mixer can be installed with or without the 'S adjuster'.



Bridge Mixers

Our bridge basin mixer has a swivelling spout and allows you to have mixed hot & cold water, whilst using a two taphole configuration.



Normal



Burlington

Spouts

Normal: The underside of a bath spout of a normal, traditional bath tap.
Burlington: The underside of a Burlington bath tap with a Neoperl aerator.

STYLE OPTIONS

Choose from a range of tap head options in finishes of either Chrome, Gold or Brushed Nickel.



Gold



Brushed Nickel



Claremont



Kensington

BRASSWARE

REGENT

Our regent base can be used on all one, two and three tap hole taps (excluding Chelsea, Stafford and CL45-QT) offering an extra 30mm of height than the standard tap base and a further 30mm away from the wall when wall-mounted.

For the full range please visit the website.



Standard



Regent

WATER PRESSURE

Our taps are designed to deliver the following maximum flows of water, regardless of the incoming water pressure:

Basin taps: 13L per minute

Bath tap: 14L per minute

Bath shower mixer: 22L per minute



Normal tap

Water flow in a normal traditional tap.



Low pressure

Low pressure water flow with a Burlington tap using a flow straightener.



High pressure

High pressure water flow with a Burlington tap using an aerator.

GUARANTEES

*For full details on guarantees please visit burlingtonbathrooms.com/guarantee.

Brassware

15
YEAR

Guarantee*

126

TRADITIONAL

128

THERMOSTATIC

128

STAFFORD

129

CHELSEA

130

RIVIERA

131

WASTES

TRADITIONAL BASIN TAPS



Basin mixer with high central indice with click-clack waste

Chrome: CL6_QT
Gold: CL6_QTGOLD
Br. Nickel: CL6_QTBNKL

Regent Option
Chrome: CLR6_QT
Gold: CLR6_QTGOLD
Br. Nickel: CLR6_QTBNKL



Basin mixer with high central indice with pop up waste

Chrome: CL4_QT
Gold: CL4_QTGOLD
Br. Nickel: CL4_QTBNKL

Regent Option
Chrome: CLR4_QT
Gold: CLR4_QTGOLD
Br. Nickel: CLR4_QTBNKL



Basin mixer with high central indice with plug & chain waste

Chrome: CL5_QT
Regent Option
Chrome: CLR5_QT



Mono basin Mixer

Chrome: CL45_QT
Gold: CL45_QTGOLD
Br. Nickel: CL45_QTBNKL



Bidet mixer with high central indice with plug & chain waste

Chrome: CL13_QT
Regent Option
Chrome: CLR13_QT



Basin tap 3"

Chrome: CL1_QT
Gold: CL1_QTGOLD
Br. Nickel: CL1_QTBNKL

Regent Option
Chrome: CLR1_QT
Gold: CLR1_QTGOLD
Br. Nickel: CLR1_QTBNKL



Basin tap 5"

Chrome: CL2_QT
Gold: CL2_QTGOLD
Br. Nickel: CL2_QTBNKL

Regent Option
Chrome: CLR2_QT
Gold: CLR2_QTGOLD
Br. Nickel: CLR2_QTBNKL



Two tap hole bridge mixer with swivelling spout with plug & chain waste

Chrome: CL10_QT
Regent Option
Chrome: CLR10_QT



Three tap hole mixer with pop up waste

Chrome: CL12_QT
Gold: CL12_QTGOLD
Br. Nickel: CL12_QTBNKL

Regent Option
Chrome: CLR12_QT
Gold: CLR12_QTGOLD
Br. Nickel: CLR12_QTBNKL

Regent Options

Our regent base which can be used on all one, two and three tap hole taps (excluding Chelsea, Stafford and CL45-QT) offering an extra 30mm of height than the standard tap base and a further 30mm away from the wall when wall-mounted.

For the full range please visit the website.



TRADITIONAL BATH TAPS



Bath shower mixer with 'S' adjuster deck-mounted

Chrome: CL15_QT
Gold: CL15_QTGOLD
Br. Nickel: CL15_QTBNKL
Regent Option
Chrome: CLR15_QT
Gold: CLR15_QTGOLD
Br. Nickel: CLR15_QTBNKL

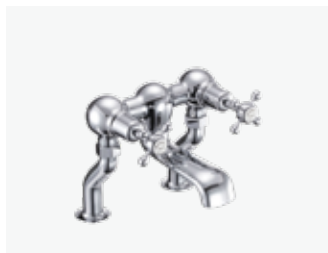

Bath filler deck-mounted

Chrome: CL23_QT
Regent Option
Chrome: CLR23_QT



Bath taps deck-mounted

Chrome: CL3_QT
Regent Option
Chrome: CLR3_QT



Bath shower mixer with 'S' adjuster wall-mounted

Chrome: CL17_QT
Gold: CL17_QTGOLD
Br. Nickel: CL17_QTBNKL
Regent Option
Chrome: CLR17_QT
Gold: CLR17_QTGOLD
Br. Nickel: CLR17_QTBNKL

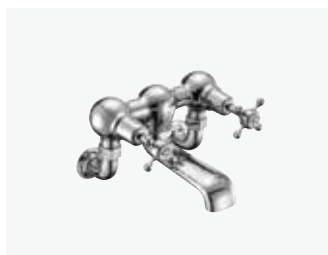

Bath filler wall-mounted

Chrome: CL24_QT
Regent Option
Chrome: CLR24_QT

Finish Options

A collection of our brassware is available in 3 distinct finishes.

These can be matched across the whole of the Burlington collection to create your perfect bathroom.



TAP HEAD OPTIONS

Choose from a wide range of tap head options in finishes of either Chrome, Gold or Brushed Nickel.

All our tap heads are available in Chrome as standard.

Claremont: The Claremont tap head is also available in Gold and Brushed Nickel.

Kensington: The Kensington tap head is available in Chrome only.

When ordering your **tap style** add the correct code to the start of the tap code:
 Claremont add CL
 Kensington add KE

Examples:
 CL6_QT
 KE6_QT

To select an **alternative finish** add the below to the end of the code:
 Gold add GOLD
 Brushed Nickel add BNKL

Examples:
 CL6_QT
 CL6_QT GOLD
 CL6_QT BNKL

Visit our website to view all the collections.



For full details on our Brassware ranges go to burlingtonbathrooms.com/guides/brassware

THERMOSTATIC

Match your basin, bath and shower with the convenience and safety of thermostatic controls for your bathroom.



Three tap hole basin mixer with pop up waste

Chrome: CL29



Thermostatic two outlet twin control bath shower mixer valve

Chrome Ceramic

Deck: BT2DS_V2_V16

Deck: BT2DS_V2_V17

Deck: BT2DS_V2_V60

Safety

We use Vernet wax capsules throughout our thermostatic brassware and showering valves, meaning temperature when in use will not vary by more than + 1 degrees.

STAFFORD

The Stafford collection cannot be paired with any other tap head options and is only available in quarter turn.



Stafford long nose basin pillar taps

Chrome: STA12_QT

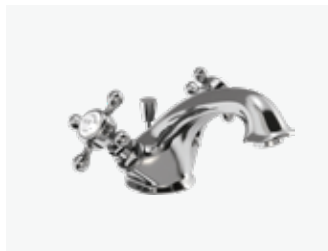

Stafford mono basin mixer with pop up waste

Chrome: STA11_QT

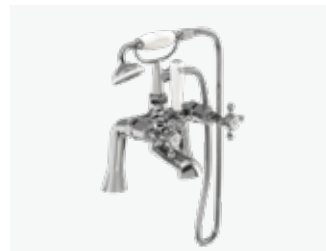

Stafford bath shower mixer deck-mounted

Chrome: STA14_QT

CHELSEA



Curved basin mixer without waste

Chrome: CH21



Curved basin mixer with pop up waste

Chrome: CH22



Curved bidet mixer with pop up waste

Chrome: CH23



Straight basin mixer without waste

Chrome: CH19



Straight basin mixer with pop up waste

Chrome: CH20



Curved tall basin mixer without waste

Chrome: CHE2



Straight tall basin mixer without waste

Chrome: CHE1

Unique Aesthetics

The Chelsea brassware range comes with its own unique, bespoke tap heads and are not available as Claremont, Anglesey or Birkenhead. Chelsea's range also comes with the choice of curved or straight spout.



For full details on our Brassware ranges go to burlingtonbathrooms.com/guides/brassware

RIVIERA

BASIN BRASSWARE



Basin mixer

Chrome: RIV8CHR
Gold: RIV8GOLD



Basin pillar taps

Chrome: RIV7CHR
Gold: RIV7GOLD

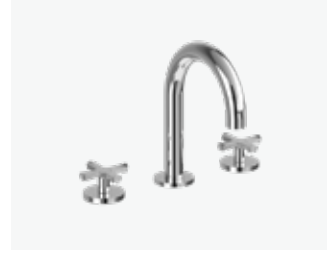

Three tap hole mixer

Chrome: RIV6CHR
Gold: RIV6GOLD



Three hole basin mixer wall-mounted

Chrome: RSCHR
Gold: RSGOLD

BATH BRASSWARE



Deck-mounted panel valves

Chrome: RIV34CHR
Gold: RIV34GOLD



Three tap hole bath mixer

Chrome: RIV32CHR
Gold: RIV32GOLD

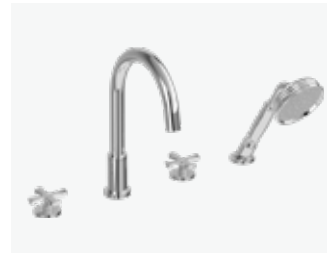

Four tap hole bath mixer

Chrome: RIV33CHR
Gold: RIV33GOLD

Riviera Range

Pair Riviera brassware with our Riviera furniture range for a truly sophisticated, Art Deco-inspired bathroom design.

For the full Riviera range, visit burlingtonbathrooms.com/riviera



Bath shower mixer with handset and hose

Chrome: RIV4CHR
Gold: RIV4GOLD



Bath legs for Riviera bath shower mixer

Chrome: RIV15CHR
Gold: RIV15GOLD



Overflow bath filler with click-clack waste

Chrome: RIV36CHR
Gold: RIV36GOLD



Overflow bath filler extension kit

Code: RIV38

For full details on our Brassware ranges go to burlingtonbathrooms.com/guides/brassware

WASTES



Shallow p trap

Chrome: CW3
Gold: CW3GOLD
Br. Nickel: CW3BNKL



Bath overflow plug & chain

Chrome: W3
Gold: W3GOLD
Br. Nickel: W3BNKL



Click clack bath waste (slotted) with chrome cover

Code: CW1



Click clack bath waste (unslotted) with chrome cover

Code: CW2



Special bath waste without a pre-drilled overflow hole

Code: CW11



Exposed bath overflow, click clack waste

Code: CW6



Exposed bath overflow, pug & chain

Chrome: W4
Gold: W4GOLD
Br. Nickel: W4BNKL



P trap connection pipe

Chrome: W21
Gold: W21GOLD
Br. Nickel: W21BNKL



Flip top basin waste, slotted

Chrome: W18
Gold: W18GOLD
Br. Nickel: W18BNKL



Click clack (push button) basin waste

Chrome: W11
Gold: W11GOLD
Br. Nickel: W11BNKL



Basin plug & chain, slotted

Chrome: W1
Gold: W1GOLD
Br. Nickel: W1BNKL



Tap hole stopper, chrome

Code: A49CHR



Flat bottom bottle trap

Code: W13



Traditional bottle trap

Chrome: W14
Gold: W14GOLD
Br. Nickel: W14BNKL



Basin tap shut off valves (hot/cold)

Code: W28



Cistern tank on/off valve

Chrome: W25
Gold: W25GOLD
Br. Nickel: W25BNKL

SHOWERING

Our range of showers provide extensive options to create a perfect showering solution. Whether you prefer showering over a bath or within an enclosure, our range of thermostatic valves offer safe and controllable showering for the entire family. Partner with a wide range of enclosure styles with corresponding trays.

KEY FEATURES

All our showers come as standard with the below key features.



One Way Water

Our non-return valves ensure the flow of water in only one direction, ensuring heating efficiency, preventing siphonage of contaminated water and keeping your shower cartridge in excellent condition for longer.



Airburst Shower Heads

By combining air and water, the pressure inside the shower head is increased. The power of a traditional shower head with up to 33% water saved.



Thermostatic Showering

Within the valve there is an automatic adjuster which maintains temperature by adjusting the flow of each supply. This is useful in guarding against the possibility of scalding. If for instance, someone flushes a WC whilst you are showering, the flow of hot water will immediately be closed down to compensate for the reduced cold water flow.

STYLE OPTIONS

Our showers are available with concealed or exposed valves.



Concealed

A concealed shower valve creates a clean finish as the valve is hidden behind the wall.



Exposed

An exposed shower valve is fitted onto the wall and has a more traditional feel.

SHOWERING

134
TRENT

135
AVON

136
EDEN

136
TAY

138
RIVIERA

140
WALK INS

144
ENCLOSURES

152
TRAYS

GUARANTEES

*The lifetime guarantee is subject to online registration and represents the perceived lifetime of the product which is 25 years. For full details on guarantees please visit burlingtonbathrooms.com/guarantee.

Showering

15
YEAR

Guarantee*

Enclosures

LIFETIME

Guarantee*

TRENT

Concealed Thermostatic Showers

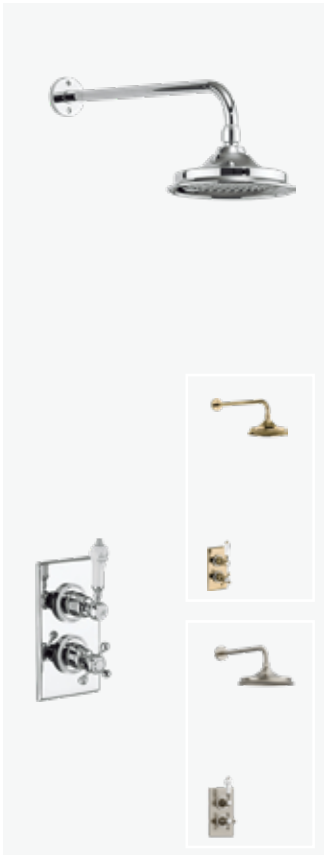

Thermostatic single function brass valve with independent temperature control

Traditional brass faceplate and Claremont handle with ceramic lever

390mm adjustable shower arm

6", 9" or 12" AirBurst shower head
(9" only for Gold and Brushed Nickel)

White Ceramic

Chrome: TF1S_V16

Chrome: TF1S_V17

Chrome: TF1S_V60

Gold: TF1SGOLD_V17

Br. Nickel: TF1SBNKL_V17

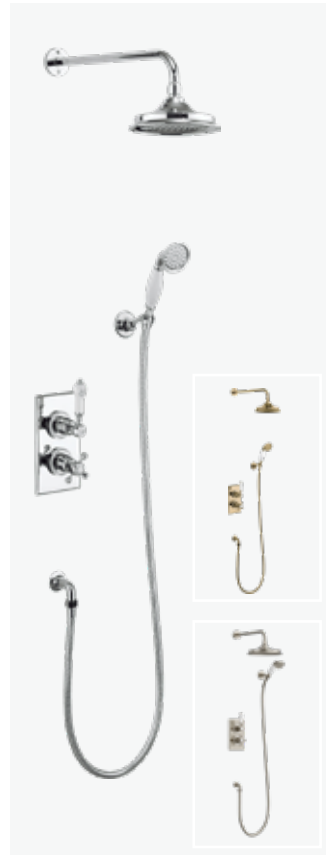

Thermostatic dual function brass valve with independent flow diverter and temperature control

Traditional brass faceplate and Claremont handle with ceramic lever

Wall outlet & 1500mm shower hose

Adjustable wall bracket and handset with ceramic handle

390mm adjustable shower arm

6", 9" or 12" AirBurst shower head
(9" only for Gold and Brushed Nickel)

White Ceramic

Chrome: TF2S_V16

Chrome: TF2S_V17

Chrome: TF2S_V60

Gold: TF2SGOLD_V17

Br. Nickel: TF2SBNKL_V17



Thermostatic single function brass valve with independent temperature control

Traditional brass faceplate and Claremont handle with ceramic lever

Slide rail including the elbow, hose and handset with ceramic handle

White Ceramic

TF1H

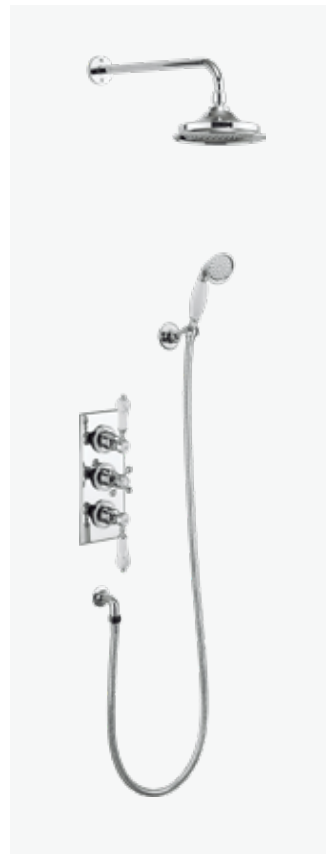

Thermostatic dual function brass valve with two independent on/off controls and central temperature control

Traditional brass faceplate and Claremont handle with ceramic lever

Wall outlet & 1500mm shower hose

Adjustable wall bracket and handset with ceramic handle

390mm adjustable shower arm

6", 9" or 12" AirBurst shower head

White Ceramic

TF3S_V16

TF3S_V17

TF3S_V60

AVON

Exposed Thermostatic Showers

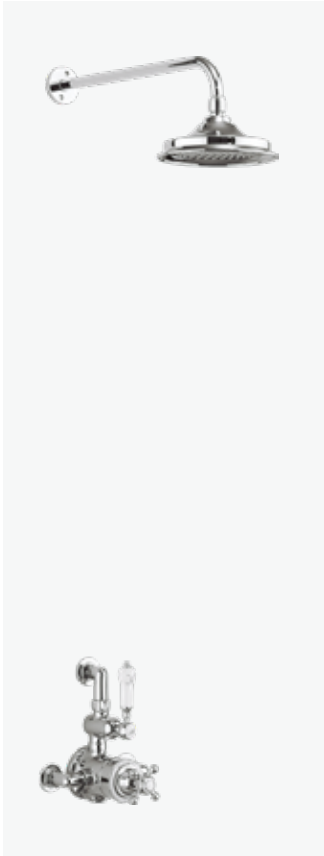

Thermostatic single function brass valve with independent temperature control

Traditional brass body and Claremont handle with ceramic lever

390mm adjustable shower arm
6", 9" or 12" AirBurst shower head

White Ceramic

AF1S_V2V16
AF1S_V2V17
AF1S_V2V60



Thermostatic dual function brass valve with two independent on/off controls & central temperature control

Traditional brass body and Claremont handle & ceramic lever

Adjustable wall bracket, 1500mm shower hose and handset with ceramic handle

18 diameter vertical shower riser
355mm adjustable swivel shower arm

6", 9" or 12" AirBurst shower head
(9" only for Gold and Brushed Nickel)

White Ceramic

Chrome: BAF3S_V2_V16
Chrome: BAF3S_V2_V17
Chrome: BAF3S_V2_V60
Gold: BAF3SGOLD_V2_V17
Br. Nickel: BAF3SBNKL_V2_V17

ACCESSORIES



Soap Basket
Chrome: V23



Cradle
Chrome: V24



Slide Rail
Chrome: V33



Ceramic Handset, Hose & Diverter
Chrome: V27

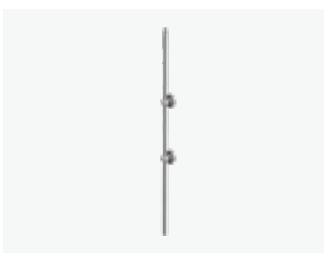

Extended Vertical Riser Rail
Chrome: V22
Gold: V22GOLD
Br. Nickel: V22BNKL

Shower Head Height

The standard riser pipe (V21) has a length of 856mm.
To increase the height of your shower head use the extended riser (V22) which has a length of 1814mm increasing the height by 958mm.
To order the extended riser simply add .EXT to the product code.
For example BSF1S changes to BSF1S.EXT

EDEN

Exposed Thermostatic Showers

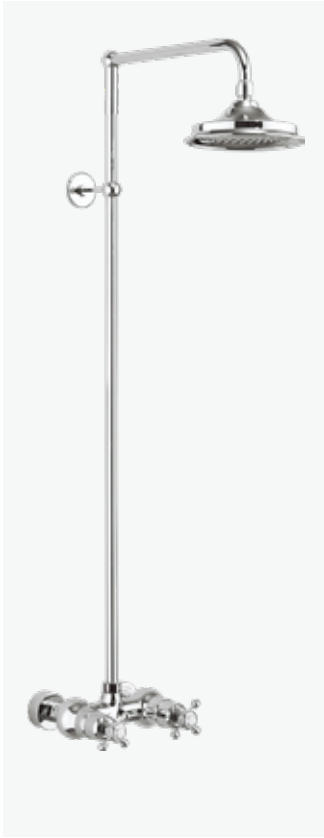

Thermostatic single outlet twin control valve with independent on / off flow and temperature control

Traditional brass body and Claremont handle with ceramic indices

18 diameter vertical brass shower riser

355mm adjustable swivel shower arm

6", 9" or 12" AirBurst shower head

White Ceramic

BEF1S_V2_V16

BEF1S_V2_V17

BEF1S_V2_V60

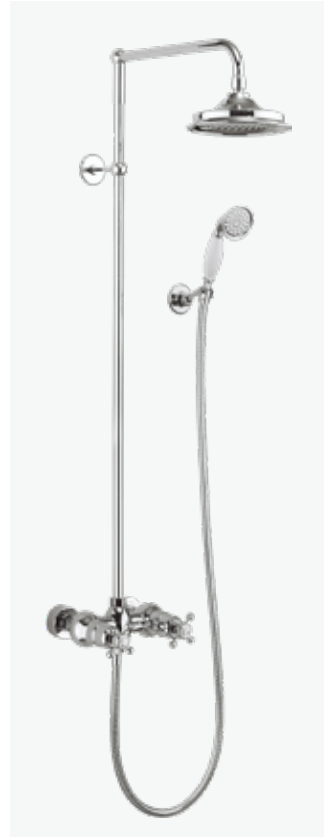

Thermostatic two outlet twin control valve with independent flow diverter and temperature control

Traditional brass body and Claremont handle with ceramic indices

Adjustable wall bracket, 1500mm shower hose and handset with ceramic handle

18 diameter vertical shower riser

390mm adjustable shower arm

6", 9" or 12" AirBurst shower head

White Ceramic

BEF2S_V2_V16

BEF2S_V2_V17

BEF2S_V2_V60

TAY

Bath Shower Thermostatic Showers

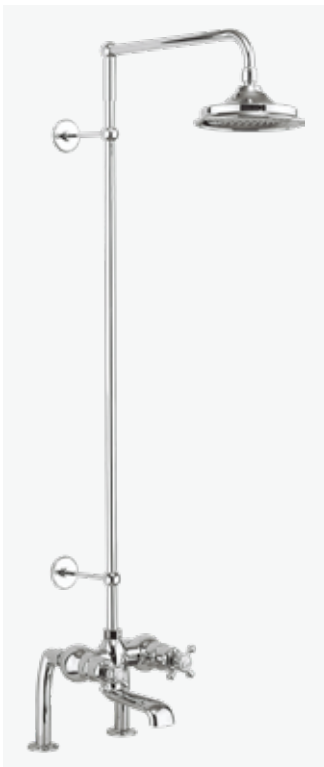

Thermostatic two outlet twin control bath shower mixer valve with independent flow diverter and temperature controls

Traditional brass body and Claremont handles, with ceramic indices

Brass bath spout with swivel function

Available deck-mounted

18 diameter vertical shower riser

355mm adjustable swivel shower arm

6", 9" or 12" AirBurst shower head

White Ceramic

BT2DS_V2_V16

BT2DS_V2_V17

BT2DS_V2_V60

ACCESSORIES

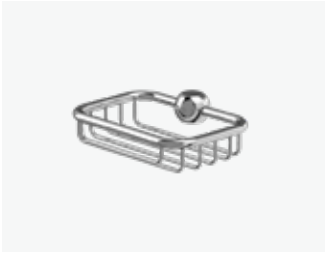

Soap Basket
Chrome: V23



Cradle
Chrome: V24

Slide Rail
Chrome: V33



Ceramic Handset, Hose & Diverter
Chrome: V27



Extended Vertical Riser Rail

Chrome: V22
Gold: V22GOLD
Br. Nickel: V22BNKL

Shower Head Height

The standard riser pipe (V21) has a length of 856mm.

To increase the height of your shower head use the extended riser (V22) which has a length of 1814mm increasing the height by 958mm.

To order the extended riser simply add .EXT to the product code.
For example BSF1S changes to BSF1S.EXT



RIVIERA

Create your perfect showering combination by selecting from the below, available in both Chrome and Gold



Single outlet version, for showers with either a fixed overhead or a flexible hose and handspray

Two outlet version for two shower outlets or for one shower and bath filling. The two outlet valve can be installed with both a fixed and flexible shower, it has a built-in diverter to switch between the two

Single Outlet

Chrome: R1SVCHR
Gold: R1SVGOLD

Dual Outlet

Chrome: R2SVCHR
Gold: R2SVGOLD

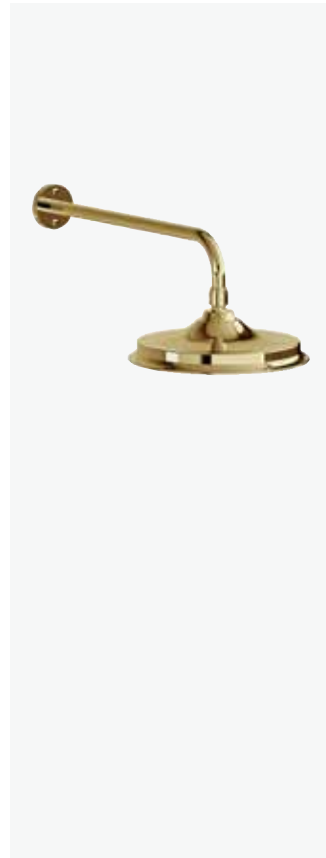

Straight shower arm

6", 9" or 12" AirBurst shower head
(9" only for Gold)

Shower Arm

Chrome: V11
Gold: V11GOLD

Shower Head

6" Chrome: V16
9" Chrome: V17
12" Chrome: V60
9" Gold: V17GOLD



100mm slidebar with adjustable bracket

Slidebar

Chrome: RIV37CHR
Gold: RIV37GOLD

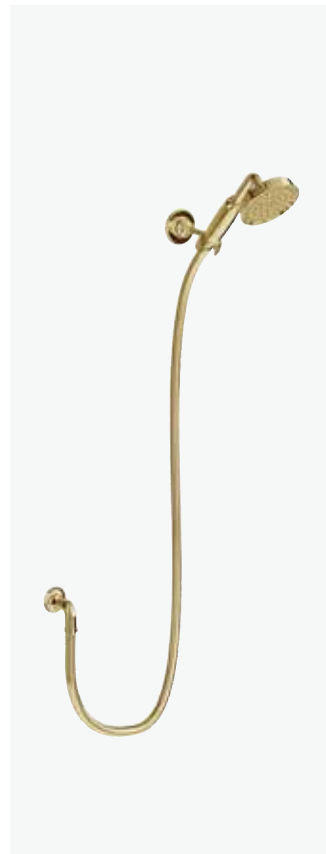

The flexible hose and handspray is supplied with wall outlet and shower station as shown. It can also be used with optional slide bar.

Fixed Hose and Handspray

Chrome: RIV20CHR
Gold: RIV20GOLD

For the full Riviera range visit
burlingtonbathrooms.com/riviera



For full details on our Riviera Showering range go to burlingtonbathrooms.com/guides/riviera-showering

WALK IN CONFIGURATIONS

Once you have identified your space you can create your personalised showering solution; with our flexible modular glass panels, profiles and stabilising fixings the layout options are almost endless.

When choosing your configuration, we recommend you allow 500mm minimum entry space.

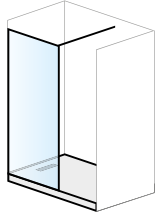

Recess

- 1 x Glass Panel
- 1 x Wall Profile
- 1 x Bracing Bar (Wall or Ceiling)

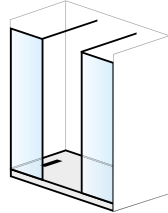

Recess with Double Panel

- 2 x Glass Panels
- 2 x Wall Profiles
- 2 x Bracing Bars (Wall or Ceiling)

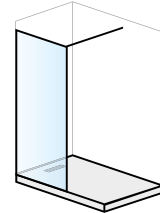

Open Ended

- 1 x Glass Panel
- 1 x Wall Profile
- 1 x Bracing Bar (Wall or Ceiling)

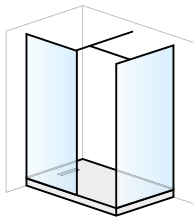

Corner with T Bracing Bar

- 2 x Glass Panels (up to 1000mm max.)
- 2 x Wall Profiles
- 1 x T Bracing Bar

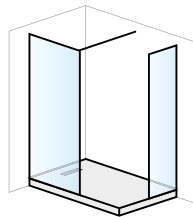

Corner

- 1 x Glass Panel
- 1 x Glass Panel (up to 500mm max.)
- 2 x Wall Profiles
- 1 x Bracing Bar (Wall or Ceiling)

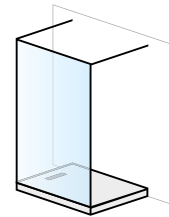

Walk Through

- 1 x Glass Panel
- 2 x Glass to Wall Bracing Bars

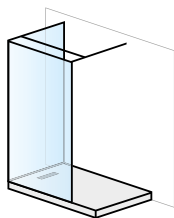

Glass Corner with T Bracing Bar

- 2 x Glass Panels (up to 1000mm max.)
- 1 x Wall Profile
- 1 x T Bracing Bar
- 1 x Glass to Glass Corner Seal

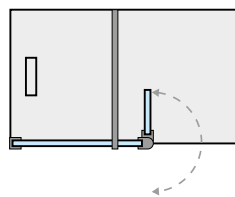

180° Hinged Deflector Panel

Available in 300mm, our hinged panel rotates through 180° for easier access. The colour matching hinges and clear seal give your walk in a seamless appearance.

- 1 x Glass Panel for Hinged Deflector
- 1 x Deflector Panel 180° Hinges (pair)

We wouldn't recommend installing a deflector panel if you have chosen a glass to ceiling bracing bar.

Additional Design Flexibility

The configurations shown are the most typical options; if you require something different please talk to your local bathroom specialist.

For further installation information or to find your local retailer visit burlingtonbathrooms.com



WALK INS



1400 x 900 Corner Walk In with Hinged Deflector Panel - Shown with Trent Shower

- 2000mm High
- Adjustable up to 15mm from each wall
- Safety glass is 8mm thick
- Easy clean coating
- Reversible panels
- 8mm toughened safety glass to BS EN 14428
- Choice of bracing bar options
- Suitable for tray or tiled floors (wetroom)
- Our hinged deflector panels can be fitted at initial installation or retrospectively

8mm Toughened Glass Panels

Width	Code
255	BU030008CF
355	BU040008CF
455	BU050008CF
555	BU060008CF
655	BU070008CF
755	BU080008CF
855	BU090008CF
955	BU100008CF
1055	BU110008CF
1155	BU120008CF
1355	BU140008CF

Panels up to 500mm can be supported with a wall profile alone, panels 600mm and wider require a bracing bar. It is important to take the measurements after the tray is installed and the walls are tiled.

Optional Glass Bottom Seal

Size	Code
1400 x 800	BUSEAL1400X8

Must be cut to length on installation.

Recommended Trays

Range	Page
Bowood 25mm Shower Trays	152
Calton 25mm Shower Trays	152
35mm Shower Trays	153

CHROME

Stabilising Fixings

Part	Size	Code
Glass to Wall Bracing Bar	1200	BUBRACEC
T Bracing Bar	1200 x 1200	BUTBRACEC
Glass to Ceiling Bracing Bar	600 High	BUCEILBRACEC
Glass to Glass Corner Seal	2000 x 10	BUSEAL2000X8

Hinged Deflector Panel Fittings

Part	Size	Code
Deflector Panel 180° Hinges	-	BUDEFHINGEC
Hinged Deflector Glass with Seal	300	BUDEFLEC300

Wall Profile

Part	Size	Adjustment	Code
Wall Profile with Seal	2000	15	BUPROFILEC

GOLD

Stabilising Fixings

Part	Size	Code
Glass to Wall Bracing Bar	1200	BUBRACEGO
T Bracing Bar	1200 x 1200	BUTBRACEGO
Glass to Ceiling Bracing Bar	600 High	BUCEILBRACEGO
Glass to Glass Corner Seal	2000 x 10	BUSEAL2000X8

Hinged Deflector Panel Fittings

Part	Size	Code
Deflector Panel 180° Hinges	-	BUDEFHINGEGO
Hinged Deflector Glass with Seal	300	BUDEFLEC300

Wall Profile

Part	Size	Adjustment	Code
Wall Profile with Seal	2000	15	BUPROFILEGO

BRUSHED NICKEL

Stabilising Fixings

Part	Size	Code
Glass to Wall Bracing Bar	1200	BUBRACEL
T Bracing Bar	1200 x 1200	BUTBRACEL
Glass to Ceiling Bracing Bar	600 High	BUCEILBRACEL
Glass to Glass Corner Seal	2000 x 10	BUSEAL2000X8

Hinged Deflector Panel Fittings

Part	Size	Code
Deflector Panel 180° Hinges	-	BUDEFHINGEL
Hinged Deflector Glass with Seal	300	BUDEFLEC300

Wall Profile

Part	Size	Adjustment	Code
Wall Profile with Seal	2000	15	BUPROFILEL

CLASSIQUE SHOWER ENCLOSURES

Bring modern luxury into your traditional bathroom design with the Classique shower enclosure range. Presenting a range of configurations, there's a luxury traditional shower enclosure for any bathroom design. The Classique range perfectly encompasses the elegance and regality of classical styles while featuring modern luxuries.

Configurations

Recessed

For a contemporary layout, opt for a recessed shower enclosure. With our selection of hinged, sliding and infold doors, find the solution that works for you.



Corner

To achieve a corner enclosure, pair any of our doors with a side panel available in a range of sizes or opt for a quadrant unit.



Personalisation

The Classique shower range elevates your traditional bathroom design with its selection of handles and finials. With two beautiful designs available, achieve a shower enclosure that harmonises with your chosen traditional bathroom style.

1850



1909



For further information or to find your local retailer visit burlingtonbathrooms.com

· NEW ·



CLASSIQUE 1850 HINGED ENCLOSURE



- 2000mm High
- Adjustable up to 20mm from each wall
- Constructed from aluminium
- Stainless steel handles and hinges
- Can be installed with or without finials
- Safety glass is 8mm thick
- 3M™ easy clean coating



Hinged Door

Finish	Width	Door Opening	Adjustment min-max	Code
Chrome	800	610	750-790	CQHDSC0800
Chrome	900	710	850-890	CQHDSC0900
Chrome	1000	810	950-990	CQHDSC1000
Gold	800	610	750-790	CQHDGC0800
Gold	900	710	850-890	CQHDGC0900
Gold	1000	810	950-990	CQHDGC1000
Br. Nickel	800	610	750-790	CQHDL0800
Br. Nickel	900	710	850-890	CQHDL0900
Br. Nickel	1000	810	950-990	CQHDL01000

Handle and Finials

Finish	Code
Chrome	CQ1850HDFNC
Gold	CQ1850HDFNG
Br. Nickel	CQ1850HDFNL

Bring the regality and elegance of traditional design to your shower enclosure with our 1850 handles and finials. Each set includes one handle and two finials to achieve a complete, coordinated look. When designing a larger enclosure that includes a side panel, an additional single finial can be ordered to allow for one in each corner.

Chrome: CQ1850PRFNC
 Gold: CQ1850PRFNG
 Br. Nickel: CQ1850PRFNL

Side Panel

Finish	Width	Adjustment min-max	Code
Chrome	800	770-790	CQSPSC0800
Chrome	900	870-890	CQSPSC0900
Gold	800	770-790	CQSPGC0800
Gold	900	870-890	CQSPGC0900
Br. Nickel	800	770-790	CQSPLC0800
Br. Nickel	900	870-890	CQSPLC0900

Recommended Trays

Range	Page
Bowood 25mm Shower Trays	152
Calton 25mm Shower Trays	152
35mm Shower Trays	153

CLASSIQUE 1909 HINGED ENCLOSURE



- 2000mm High
- Adjustable up to 20mm from each wall
- Constructed from aluminium
- Stainless steel handles and hinges
- Can be installed with or without finials
- Safety glass is 8mm thick
- 3M™ easy clean coating



Hinged Door

Finish	Width	Door Opening	Adjustment min-max	Code
Chrome	800	610	750-790	CQHDSC0800
Chrome	900	710	850-890	CQHDSC0900
Chrome	1000	810	950-990	CQHDSC1000
Gold	800	610	750-790	CQHDGC0800
Gold	900	710	850-890	CQHDGC0900
Gold	1000	810	950-990	CQHDGC1000
Br. Nickel	800	610	750-790	CQHDL0800
Br. Nickel	900	710	850-890	CQHDL0900
Br. Nickel	1000	810	950-990	CQHDL01000

Handle and Finials

Finish	Code
Chrome	CQ1909HDFNC
Gold	CQ1909HDFNG
Br. Nickel	CQ1909HDFNL

Bring the regality and elegance of traditional design to your shower enclosure with our 1909 handles and finials. Each set includes one handle and two finials to achieve a complete, coordinated look. When designing a larger enclosure that includes a side panel, an additional single finial can be ordered to allow for one in each corner.

Chrome: CQ1850PRFNC
 Gold: CQ1850PRFNG
 Br. Nickel: CQ1850PRFNL

Side Panel

Finish	Width	Adjustment min-max	Code
Chrome	800	770-790	CQSPSC0800
Chrome	900	870-890	CQSPSC0900
Gold	800	770-790	CQSPGC0800
Gold	900	870-890	CQSPGC0900
Br. Nickel	800	770-790	CQSPLC0800
Br. Nickel	900	870-890	CQSPLC0900

Recommended Trays

Range	Page
Bowood 25mm Shower Trays	152
Calton 25mm Shower Trays	152
35mm Shower Trays	153

CLASSIQUE 1850 SLIDING DOOR ENCLOSURE



- 2000mm High
- Adjustable up to 20mm from each wall
- Constructed from aluminium
- Stainless steel handles and hinges
- Can be installed with or without finials
- Safety glass is 8mm thick
- 3M™ easy clean coating



Sliding Door

Finish	Width	Door Opening	Adjustment min-max	Code
Chrome	1200	446	1150-1190	CQSLSC1200
Chrome	1400	546	1350-1390	CQSLSC1400
Chrome	1700	546	1650-1690	CQSLSC1700
Gold	1200	446	1150-1190	CQSLGC1200
Gold	1400	546	1350-1390	CQSLGC1400
Gold	1700	546	1650-1690	CQSLGC1700
Br. Nickel	1200	446	1150-1190	CQSLLC1200
Br. Nickel	1400	546	1350-1390	CQSLLC1400
Br. Nickel	1700	546	1650-1690	CQSLLC1700

Handle and Finials

Finish	Code
Chrome	CQ1850HDFNC
Gold	CQ1850HDFNG
Br. Nickel	CQ1850HDFNL

Bring the regality and elegance of traditional design to your shower enclosure with our 1850 handles and finials. Each set includes one handle and two finials to achieve a complete, coordinated look. When designing a larger enclosure that includes a side panel, an additional single finial can be ordered to allow for one in each corner.

Chrome: CQ1850PRFNC
 Gold: CQ1850PRFNG
 Br. Nickel: CQ1850PRFNL

Side Panel

Finish	Width	Adjustment min-max	Code
Chrome	800	770-790	CQSPSC0800
Chrome	900	870-890	CQSPSC0900
Gold	800	770-790	CQSPGC0800
Gold	900	870-890	CQSPGC0900
Br. Nickel	800	770-790	CQSPLC0800
Br. Nickel	900	870-890	CQSPLC0900

Recommended Trays

Range	Page
Bowood 25mm Shower Trays	152
Calton 25mm Shower Trays	152
35mm Shower Trays	153

CLASSIQUE 1909 SLIDING DOOR ENCLOSURE



- 2000mm High
- Adjustable up to 20mm from each wall
- Constructed from aluminium
- Stainless steel handles and hinges
- Can be installed with or without finials
- Safety glass is 8mm thick
- 3M™ easy clean coating



Sliding Door

Finish	Width	Door Opening	Adjustment min-max	Code
Chrome	1200	446	1150-1190	CQSLSC1200
Chrome	1400	546	1350-1390	CQSLSC1400
Chrome	1700	546	1650-1690	CQSLSC1700
Gold	1200	446	1150-1190	CQSLGC1200
Gold	1400	546	1350-1390	CQSLGC1400
Gold	1700	546	1650-1690	CQSLGC1700
Br. Nickel	1200	446	1150-1190	CQSLLC1200
Br. Nickel	1400	546	1350-1390	CQSLLC1400
Br. Nickel	1700	546	1650-1690	CQSLLC1700

Handle and Finials

Finish	Code
Chrome	CQ1909HDFNC
Gold	CQ1909HDFNG
Br. Nickel	CQ1909HDFNL

Bring the regality and elegance of traditional design to your shower enclosure with our 1909 handles and finials. Each set includes one handle and two finials to achieve a complete, coordinated look. When designing a larger enclosure that includes a side panel, an additional single finial can be ordered to allow for one in each corner.

Chrome: CQ1850PRFNC
 Gold: CQ1850PRFNG
 Br. Nickel: CQ1850PRFNL

Side Panel

Finish	Width	Adjustment min-max	Code
Chrome	800	770-790	CQSPSC0800
Chrome	900	870-890	CQSPSC0900
Gold	800	770-790	CQSPGC0800
Gold	900	870-890	CQSPGC0900
Br. Nickel	800	770-790	CQSPLC0800
Br. Nickel	900	870-890	CQSPLC0900

Recommended Trays

Range	Page
Bowood 25mm Shower Trays	152
Calton 25mm Shower Trays	152
35mm Shower Trays	153

CLASSIQUE 1850 QUADRANT ENCLOSURE



- 2000mm High
- Adjustable up to 20mm from each wall
- Constructed from aluminium
- Stainless steel handles and hinges
- Can be installed with or without finials
- Safety glass is 8mm thick
- 3M™ easy clean coating



Quadrant Door

Finish	Width	Door Opening	Adjustment min-max	Code
Chrome	800	391	760-780	CQQSSC0800
Chrome	900	440	860-880	CQQSSC0900
Gold	800	391	760-780	CQQSGC0800
Gold	900	440	860-880	CQQSGC0900
Br. Nickel	800	391	760-780	CQQSLC0800
Br. Nickel	900	440	860-880	CQQSLC0900

Handle and Finials

Finish	Code
Chrome	CQ1850HDFNC
Gold	CQ1850HDFNG
Br. Nickel	CQ1850HDFNL

Bring the regality and elegance of traditional design to your shower enclosure with our 1850 handles and finials. Each set includes one handle and two finials to achieve a complete, coordinated look.

Chrome: CQ1850PRFNC
 Gold: CQ1850PRFNG
 Br. Nickel: CQ1850PRFNL

Recommended Trays

Range	Page
Bowood 25mm Shower Trays	152
Calton 25mm Shower Trays	152
35mm Shower Trays	153

CLASSIQUE 1909 QUADRANT ENCLOSURE



- 2000mm High
- Adjustable up to 20mm from each wall
- Constructed from aluminium
- Stainless steel handles and hinges
- Can be installed with or without finials
- Safety glass is 8mm thick
- 3M™ easy clean coating



Quadrant Door

Finish	Width	Door Opening	Adjustment min-max	Code
Chrome	800	391	760-780	CQQSSC0800
Chrome	900	440	860-880	CQQSSC0900
Gold	800	391	760-780	CQQSGC0800
Gold	900	440	860-880	CQQSGC0900
Br. Nickel	800	391	760-780	CQQSLC0800
Br. Nickel	900	440	860-880	CQQSLC0900

Handle and Finials

Finish	Code
Chrome	CQ1909HDFNC
Gold	CQ1909HDFNG
Br. Nickel	CQ1909HDFNL

Bring the regality and elegance of traditional design to your shower enclosure with our 1909 handles and finials. Each set includes one handle and two finials to achieve a complete, coordinated look.

Chrome: CQ1850PRFNC
 Gold: CQ1850PRFNG
 Br. Nickel: CQ1850PRFNL

Recommended Trays

Range	Page
Bowood 25mm Shower Trays	152
Calton 25mm Shower Trays	152
35mm Shower Trays	153



BOWOOD 25MM SHOWER TRAYS



Square

Length	Width	Code
800	800	BU_CRS800X800W
900	900	BU_CRS900X900W



Rectangle

Length	Width	Code
1200	760	BU_CRR760X1200W
1400	760	BU_CRR760X1400W
1200	800	BU_CRR800X1200W
1400	800	BU_CRR800X1400W
1700	800	BU_CRR800X1700W
1200	900	BU_CRR900X1200W
1400	900	BU_CRR900X1400W
1700	900	BU_CRR900X1700W



Quadrant

Length	Width	Code
800	800	BU_CRQ800X800W
900	900	BU_CRQ900X900W

Bowood Shower Tray Waste 90mm

Product	Width	Depth	Height	Code
Waste	115	130	110	BU_CRHFWS90
Leg Set	-	-	-	BU_TRAY25MMLLEGSET8



CALTON 25MM SHOWER TRAYS



Square

Length	Width	Code
900	900	BU_VTS900W



Rectangle

Length	Width	Code
1200	760	BU_VTR760X1200W
1200	800	BU_VTR800X1200W
1400	800	BU_VTR800X1400W
1700	800	BU_VTR800X1700W
1200	900	BU_VTR900X1200W
1400	900	BU_VTR900X1400W
1700	900	BU_VTR900X1700W

Calton Shower Tray Waste & Leg Set

Product	Width	Depth	Height	Code
Waste	115	130	110	BU_VTHFWS90
Leg Set	-	-	-	BU_TRAY25MMLLEGSET8

35MM SHOWER TRAYS

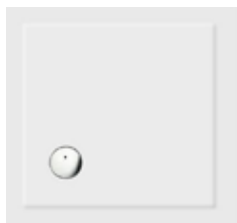

Square shower trays

Length	Width	Code	Panel Pack
900	900	Z1161	*



Quadrant shower trays

Length	Width	Code	Panel Pack
900	900	Z1193	*



Rectangle - corner waste

Length	Width	Code	Panel Pack
900	800	Z1164	*
1000	800	Z1167	A
1000	900	Z1168	A
1100	900	Z1172	B
1200	760	Z1174	B

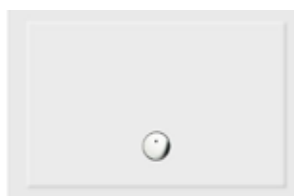

Rectangle - off-centre waste

Length	Width	Code	Anti-Slip Code	Panel Pack
1200	800	Z1175	Z1175A	B
1200	900	Z1176	Z1176A	B
1400	800	Z1177	Z1177A	B
1400	900	-	Z1178A	B



Large rectangle

Length	Width	Code	Anti-Slip Code	Panel Pack
1500	800	Z1181	Z1181A	B
1500	900	Z1361	Z1361A	B
1600	700	-	Z1182A	B
1600	800	Z1231	Z1231A	B
1700	700	Z1183	Z1183A	B
1700	760	-	Z1184A	B
1700	800	Z1185	Z1185A	B
1700	900	-	Z1341A	B



Shower tray panel packs

Code	Panel Pack
Z1209 (ZP1.ZL1)	A
Z1210 (ZP2.ZL2)	B
Z1213 (ZP5.ZL3)	E
Z1215 (ZP4.ZL5)	G
Z1217 (ZP1.ZL2)	I



High Flow Vortex Shower Waste

Finish	Width	Depth	Height	Code
Chrome	115	130	110	Z1205
Gold	115	130	110	Z1205GOLD
Br. Nickel	115	130	110	Z1205BNKL

* No panel pack available

ACCESSORIES

Burlington bathrooms offer a range of accessories, radiators, mirrors and lights for the perfect finishing touch to your traditionally styled bathroom.

COLOUR OPTIONS

Continue luxury styling throughout your classic themed bathroom with a range of accessories combining Chrome, Gold or Brushed Nickel plated solid brass with White ceramic so your bathroom not only looks beautifully traditional but is effortlessly functional too.



Accessories

Continue luxury styling throughout your classic themed bathroom with a range of accessories in a selection of finishes. Choose from Chrome, Gold or Brushed Nickel finish.



Radiators

Complete your traditional bathroom with a choice of radiators in either White and Chrome, Black and Chrome, Chrome, Gold or Brushed Nickel.



Mirrors

Add a finishing touch to your bathroom with a Burlington mirror. Opt for Arch, Rectangular, Oval or Round mirrors with Chrome, Gold or Brushed Nickel fixings.



Lights

Choose from a selection of Burlington lights with Chrome, Gold or Brushed Nickel bases and a choice of either glass or chiffon shades.

ACCESSORIES

156
ACCESSORIES

158
RADIATORS

159
MIRRORS

160
LIGHTS

GUARANTEES

*For full details on guarantees please visit
burlingtonbathrooms.com/guarantee.

Accessories

15
YEAR

Guarantee*

Mirrors

5
YEAR

Guarantee*

Radiators

5
YEAR

Guarantee*

Lights

5
YEAR

Guarantee*

ACCESSORIES



Soap Dish
W: 160 **L:** 150 **H:** 60
Chrome: A1CHR
Gold: A1GOLD
Br. Nickel: A1BNKL



Tumbler Holder
W: 80 **L:** 120 **H:** 110
Chrome: A2CHR
Gold: A2GOLD
Br. Nickel: A2BNKL



WC Brush Holder
W: 100 **L:** 150 **H:** 430
Chrome: A8CHR
Gold: A8GOLD
Br. Nickel: A8BNKL



Freestanding WC Brush Holder
W: 104 **L:** 104 **H:** 421
Chrome: BUR025C
Gold: BUR025G
Br. Nickel: BUR025L



Towel Ring
W: 170 **L:** 60 **H:** 200
Chrome: A3CHR
Gold: A3GOLD
Br. Nickel: A3BNKL



Single Soap Dispenser
W: 80 **L:** 140 **H:** 210
Chrome: A19CHR
Gold: A19GOLD
Br. Nickel: A19BNKL



Double Soap Dispenser
W: 190 **L:** 130 **H:** 210
Code: A20CHR

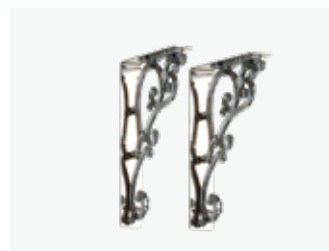

Medium Ornate Bracket for WC
W: 230 **L:** 20 **H:** 160
Code: T32CHR



WC Roll Holder
W: 80 **L:** 180 **H:** 120
Chrome: A5CHR
Gold: A5GOLD
Br. Nickel: A5BNKL

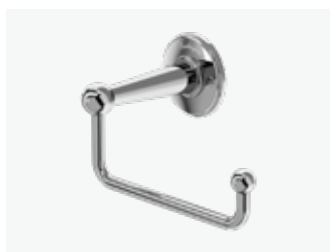

WC Roll Holder
W: 100 **L:** 180 **H:** 100
Code: A16CHR



Spire WC Roll Holder
W: 170 **L:** 60 **H:** 250
Code: A45CHR

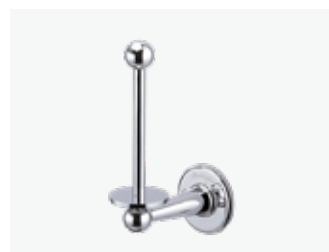

Spare WC Roll Holder
W: 120 **L:** 60 **H:** 80
Code: A6CHR

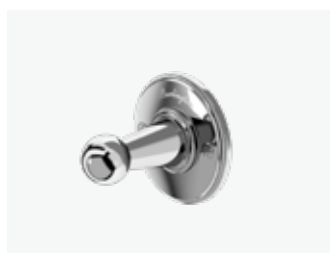

Robe Hook
W: 60 **L:** 60 **H:** 60
Chrome: A14CHR
Gold: A14GOLD
Br. Nickel: A14BNKL

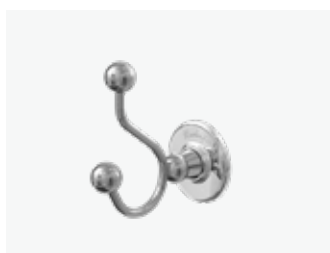

Double Robe Hook
W: 60 **L:** 110 **H:** 120
Chrome: A4CHR
Gold: A4GOLD
Br. Nickel: A4BNKL



Triple Robe Hook
W: 100 **L:** 70 **H:** 90
Code: A47CHR

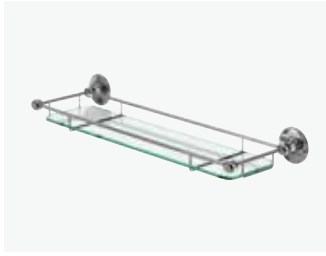

Glass Shelf with Railing

W: 530 **L:** 160 **H:** 60

Code: A18CHR



Brass Extendible Bath Rack

W: 590-900 **L:** 210 **H:** 90

Code: A27CHR



Soap Basket

W: 140 **L:** 120 **H:** 60

Code: A13CHR

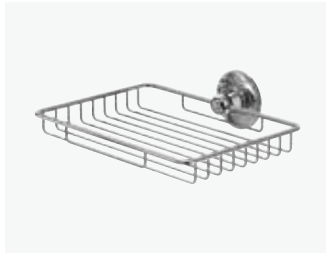

Sponge Basket

W: 220 **L:** 180 **H:** 60

Code: A15CHR



Wire Basket

W: 330 **L:** 160 **H:** 90

Code: A23CHR



Corner Basket

W: 220 **L:** 220 **H:** 60

Code: A21CHR



Deep Corner Basket

W: 280 **L:** 280 **H:** 90

Code: A22CHR

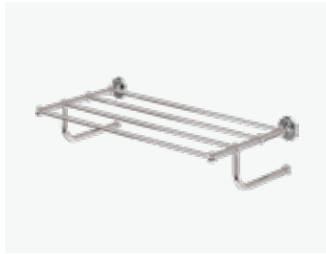

Towel Rack

W: 660 **L:** 320 **H:** 140

Chrome: A46CHR

Gold: A46GOLD



Single Towel Rail

W: 550 **L:** 60 **H:** 60

Code: A7CHR



Double Towel Rail

W: 660 **L:** 150 **H:** 170

Code: A17CHR

COLOUR CHOICES

A selection of our accessories are available in a range of finishes and accents. See below for a few examples. For details on exact finishes visit our website.



Chrome

Brushed Nickel

Gold

RADIATORS



Trafalgar
W: 642 **L:** 235 **H:** 950
Chrome: R1CHR
Gold: R1GOLD
Br. Nickel: R1BNKL



Trafalgar Black
W: 642 **L:** 235 **H:** 950
Code: R1CHRBLA



Bloomsbury
W: 497 **L:** 235 **H:** 950
Chrome: R2CHR
Gold: R2GOLD
Br. Nickel: R2BNKL



Bloomsbury Black
W: 497 **L:** 235 **H:** 950
Code: R2CHRBLA



Chaplin
W: 542 **L:** 126 **H:** 1142
Code: R12CHR



Berkeley
W: 642 **L:** 235 **H:** 950
Chrome: R4CHR
Gold: R4GOLD
Br. Nickel: R4BNKL



Cleaver
W: 642 **L:** 235 **H:** 720
Chrome: R3CHR
Gold: R3GOLD
Br. Nickel: R3BNKL



Strand
W: 642 **L:** 390 **H:** 404
Code: R11CHR



Straight Radiator Valves
Chrome: R7CHR
Gold: R7GOLD
Br. Nickel: R7BNKL



Angled Radiator Valves
Chrome: R6CHR
Gold: R6GOLD
Br. Nickel: R6BNKL

Suitable for Chrome only



300W summer electric heating kit for Trafalgar and Bloomsbury

Code: BUR10

200W summer electric heating kit for Chaplin and Vincent

Code: BUR9

100W summer electric heating kit for Berkeley and Cleaver

Code: BUR8

Type	$\Delta T=50^{\circ}C$ Watts	$\Delta T=55^{\circ}C$ Watts	$\Delta T=60^{\circ}C$ Watts	BTU's	DM3
Trafalgar	475	540	600	2047	7.2
Bloomsbury	356	400	445	1518	5.0
Berkeley	180	210	240	819	2.4
Cleaver	164	190	210	717	2.2
Strand	218	250	280	955	2.4
Chaplin	235	268	300	1024	3.4

Maximum capacity when using a heating element is 90% of full capacity. Please consult the installation guide for each model.

Burlington radiators offer a broad range of various styles.

There are options here to complement your traditional bathroom beautifully. All Burlington radiators except the Strand (R11 CHR) are designed to work with the extra fitting of an electric summer heating kit, allowing warm towels all year round.

MIRRORS



Arch Mirror

450x650: MIRAR45X65
550x750: MIRAR55X75

Fixings sold separately



Rectangular Mirror

450x650: MIRRE45X65
650x850: MIRRE65X85

Fixings sold separately



Oval Mirror

400x500: MIROV40X50
500x700: MIROV50X70
600x800: MIROV60X80

Fixings sold separately



Round Mirror

400 ø: MIRRU40
500 ø: MIRRU50
600 ø: MIRRU60

Fixings sold separately



Mirror Fixings 1850

Chrome: MI18501C
Gold: MI18501G
Br. Nickel: MI18501L



Mirror Fixings 1909

Chrome: MI19091C
Gold: MI19091G
Br. Nickel: MI19091L

Our new range of mirrors allows for complete personalisation to harmonise with any traditional bathroom design. Select one of our four mirror styles: Arch, Rectangular, Oval or Round. Each style comes with a choice of either our 1850 or 1909 fixings available in Gold, Brushed Nickel or Chrome.



Rectangular

W: 500 **D:** 30 **H:** 700

Code: A11



Rectangular Swivel Mirror with Curved Corners

W: 590 **D:** 66 **H:** 620

Chrome: A40CHR
Gold: A40GOLD
Br. Nickel: A40BNKL



Cosmetic Wall Mirror

W: 180 **D:** 285 **H:** 340-440

Code: A57CHR

LIGHTS



Round Light with Chrome Base and Cup Frosted Glass Shade

Code: EL_BL11



Round Light with Chrome Base and Vase Clear Glass Shade

Code: EL_BL14



Round Light with Chrome Base and Tube Frosted Glass Shade

Chrome: EL_BL13
Gold: EL_BL13GOLD
Br. Nickel: EL_BL13BNKL



Round Light with Chrome Base and White Fine Pleated Shade

Chrome: EL_BL12
Gold: EL_BL12GOLD
Br. Nickel: EL_BL12BNKL



Round Light with Chrome Base and Silver Chiffon Shade

Code: EL_BL15

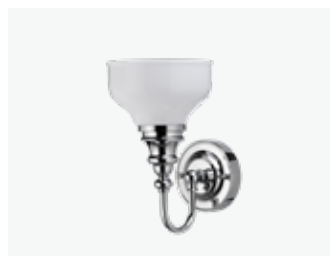

Ornate Light with Chrome Base and Cup Frosted Glass Shade

Code: EL_BL21



Ornate Light with Chrome Base and Vase Clear Glass Shade

Chrome: EL_BL24
Gold: EL_BL24GOLD
Br. Nickel: EL_BL24BNKL



Ornate Light with Chrome Base and Tube Frosted Glass Shade

Chrome: EL_BL23
Gold: EL_BL23GOLD
Br. Nickel: EL_BL23BNKL



Ornate Light with Chrome Base and White Fine Pleated Shade

Chrome: EL_BL22
Gold: EL_BL22GOLD
Br. Nickel: EL_BL22BNKL



Ornate Light with Chrome Base and Silver Chiffon Shade

Code: EL_BL25

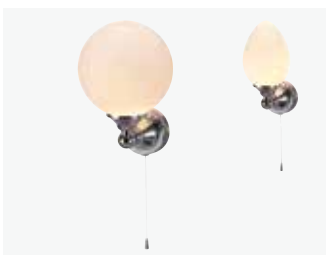

Edwardian Chrome Single Round LED Light

Round: T50
Elliptical: T52



ONLINE

You can view all of the Burlington collections on our website alongside exclusive videos, styling tips for your bathroom and technical details about the product. If you would prefer to view in person, you can use the website's showroom locator to find your nearest Burlington display.

IN STORE

There is a local Burlington specialist near you.
To find your nearest retailer, search our website under
burlingtonbathrooms.com/find-a-retailer

GUARANTEES

All Burlington products are made using the highest quality materials and are produced to meet or exceed European and U.K. Standards. With correct installation and use the products will give many years of trouble-free service.

All products within the brand are covered by Burlington's guarantees. Burlington guarantees are subject to online registration. Lifetime guarantees represent the perceived lifetime of the product which is 25 years.

For more information on guarantees visit
burlingtonbathrooms.com/guarantee

INSPIRATION

Follow us on



burlingtonbathrooms.com



February 2025



Part of the
Bathroom Brands Group
burlingtonbathrooms.com

Lake View House
Rennie Drive, Dartford
Kent, DA1 5FU

