

PRODUCT DATA SHEET

Burlington[®]

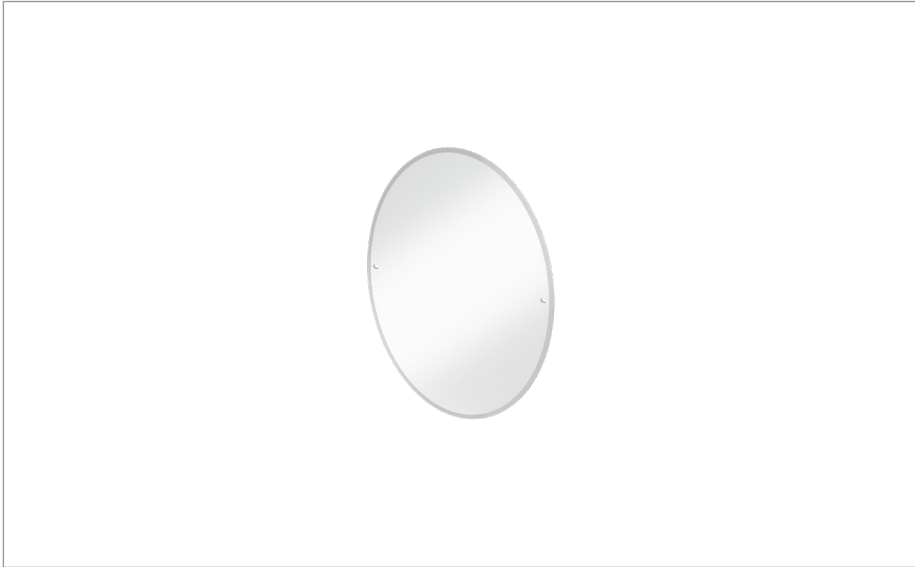

PRODUCT CODE

MIROV50X70

RANGE

Burlington

DESCRIPTION

Oval Mirror 500 x 700 x 5mm

WEBSITE LINK [Click Here](#)

CATEGORY	Cabinets & Mirrors
WARRANTY DETAILS	5 Years
PRIMARY MATERIAL	Glass
INSTALL TYPE	Wall Mounted
PRODUCT WIDTH MM	500
PRODUCT HEIGHT MM	700
PRODUCT LENGTH MM	5
PRODUCT NET WEIGHT KG	3.34
STANDARDS	ISO 9001

HANDING MIRROR & CABINETS	Universal
TEMPERATURE CHANGING	No
SHELVES ADJUSTABLE	No
SHAVER SOCKET INCLUDED	No
DIMMABLE	No

TECHNICAL DIMENSIONS

Dimensions in mm unless otherwise specified.

Tolerances (per material type) apply.

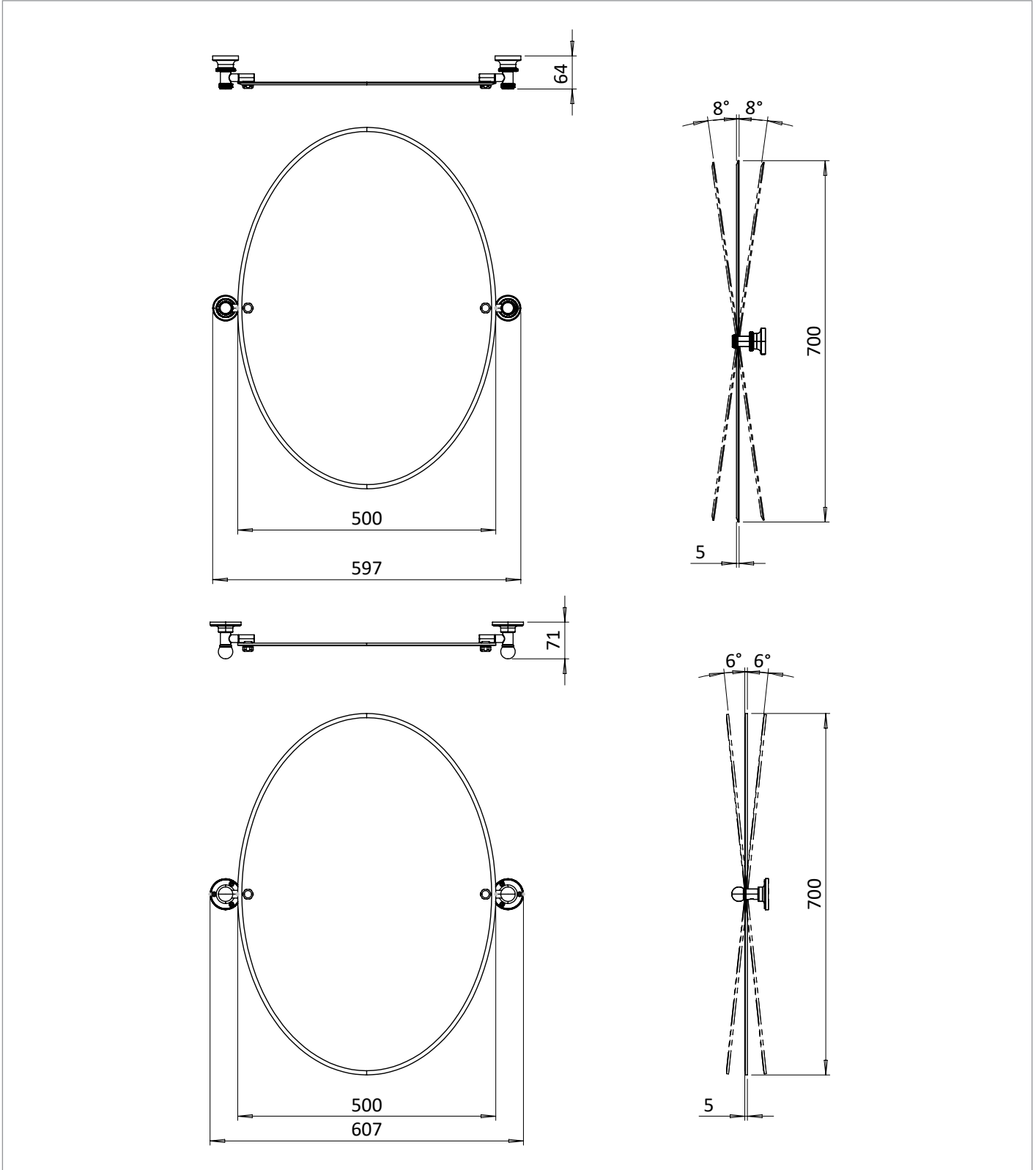

SPARES LIST

Only the parts labelled are available as spares.

NO SPARES AVAILABLE